

**This article details the importance of compliance in the supply of complex containment equipment, and highlights how critical it is to the successful completion of a project. It investigates the benefits of providing a single focused group to take responsibility for the compliance function and how that group delivers its role.**

Reprinted from  
**PHARMACEUTICAL ENGINEERING**

The Official Journal of ISPE  
March/April 2000, Vol. 20 No. 2

## Structure for Compliance in the Supply of Containment Systems

by John Nichols and Stuart Preston

### Introduction

**W**ithin the pharmaceutical industry, the qualification of equipment and facilities is an integral part of ensuring that they are fit-for-purpose and achieving the overall goals of Good Manufacturing Practice (GMP). The requirement for compliance has increased in complexity as a result of the integration of equipment with facility design, the increase in production Information Technology (IT), and data recording together with more sophisticated control systems. In addition to the complexity, there also has been an increase in the amount of highly active and cytotoxic products produced within the industry, which has led to the use of more unique and complex containment systems for the provision of operator and product protection.

Typical containment systems developed within the industry for the manufacturing of products are: Horizontal Laminar Flow Booths,

Downflow Containment Booths, X-Flow Booths, High Containment Barrier Isolators “enclosing product operation,” or a combination of the aforementioned with specific production techniques. An example of one such containment system is shown in Figure 1. Containment systems within a production facility can be an independent upgrade of an existing production unit or a small section within a larger project.

In the installation of containment systems such equipment cannot be considered as individual or stand-alone. They interact across several disciplines and departments within most company structures. As a consequence, coordinating the requirements of documentation, design and GMP is more demanding and hence a greater degree of control is required.

With all the demands, production facility start-up delays are costly and are increasingly problematic for the pharmaceutical industry. In today’s environment, the industry is striving

Figure 1. High-Containment barrier isolator.



for 'speed to marketplace', aware that in the current competitive climate the 'first to market' wins. Project costs increase due to delays to the schedule, and a project team that underestimates the complexity and involvement of implementation will compound an already demanding requirement. The schedule of compliance documentation is often mis-planned and is late in implementation from the start of the project, resulting in delays, frustration and late issues of manuals etc. Better documentation control and project management is required for this obstacle to be removed. A delay in the complete plant handover (the plant is not complete until the paperwork is done) affects a range of issues including GMP for extended validation programs.

Frequently, suppliers for this industry do not fully understand or are not willing to ensure compliance issues are fully implemented. This is not in keeping with the spirit of alliance or a partnering concept of working.

The increased compliance requirement and its complexities should not be an obstacle for the industry pushing forward with higher efficiencies and better utilization of facilities design. In fact, the outsourcing of compliance through suppliers should make for far more effective project implementation. Delays can be avoided with better documentation and design control.

To counteract the problems outlined above, a solution provided by one company supplying containment systems was to form a dedicated "Technology Compliance Group."

### Technology Compliance Group

Due to the increased need to move forward the documentation and validation for the pharmaceutical industry in meeting the regulatory requirements for the Year 2000, pharmaceutical equipment manufacturers need to control critical areas under a single group.

The Compliance Group structure in the provision of containment systems is based very much upon teamwork. During the sourcing of such complex systems, vendors and their suppliers play an equally important role in the supply of the equipment. Demands are made from both parties in terms of expert design, installation, commissioning, and validation. The compliance input in the supply of a containment system rests with the vendor for approximately 75% of the input. They are responsible for organizing home and site activities to achieve the project schedule and in particular the compliance documentation, IQ (Installation Qualification)/OQ (Operational Qualification) and sometimes PQ (Process Qualification) with the product. It is essential to have clear coordination and clearly defined roles in this situation.

As we are all aware, controlling the documentation for validation in line with the design documents can be problem-

atic within organizations. As a consequence, the Compliance Group brings together the engineering and validation system as total compliance into one single group.

The structure of the Technology Compliance Group is demonstrated in Figure 2. In order to ensure teamwork, the Group has an individual responsible for each of the following:

- Compliance Group as a whole
- Commissioning and Validation
- Servicing
- Documentation
- Quality Assurance
- Health and Safety

The advantages of a single group system are:

- validation specialist in one location
- direct control and coordination of documentation
- standardized protocols in one control system
- economical operation costs using a single group

It is imperative that each area is undertaken by an adequate number of competent people. Documentation is key when you take into consideration the rule, "If it is not documented, it is not done." The control rests with a single group. The group implements the appropriate system, which allows one to plan ahead and control the documentation development.

The improvements within manufacturing technology for containment equipment and systems make the compliance documentation more complex and incurs greater output, quality and efficiency. The complexity has increased and in-house skills are relied upon across engineering and design departments.

As a result, equipment manufacturers must improve their performance and customer satisfaction by taking the responsibility of managing the process to achieve the intended outcome. Both parties gain through a better understanding of the compliance requirements.

Documented systems and procedures will ensure that the key elements of compliance are achieved in-line with the customer requirements. Documents are intended to control and validate the information and to assess 'fitness-for-purpose' of the goods and services provided to the customer. This will be carried out in accordance with the user and compliance requirements directed by the customer.

All acceptance criteria agreed with the customer will be validated using the Compliance Group in accordance with the defined tests and procedures in the detailed protocols. The boundaries of all validation work including the associated documentation will be jointly agreed upon in the validation plans.

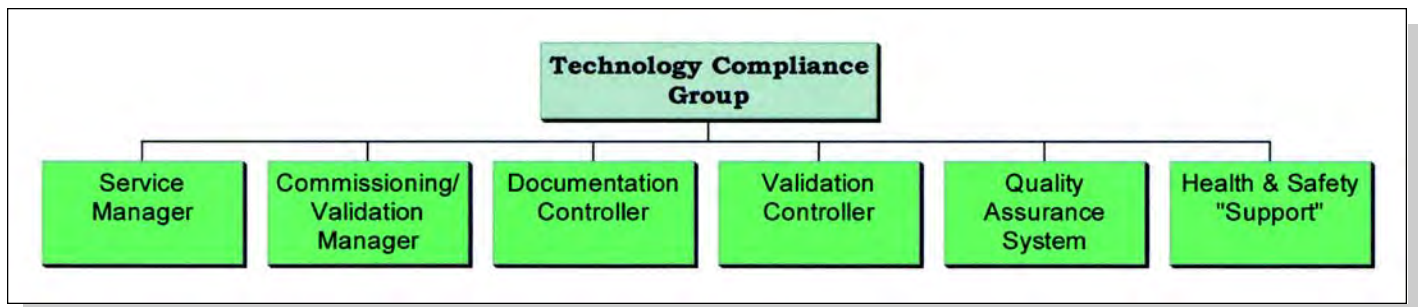

Figure 2. Technology compliance group structure.

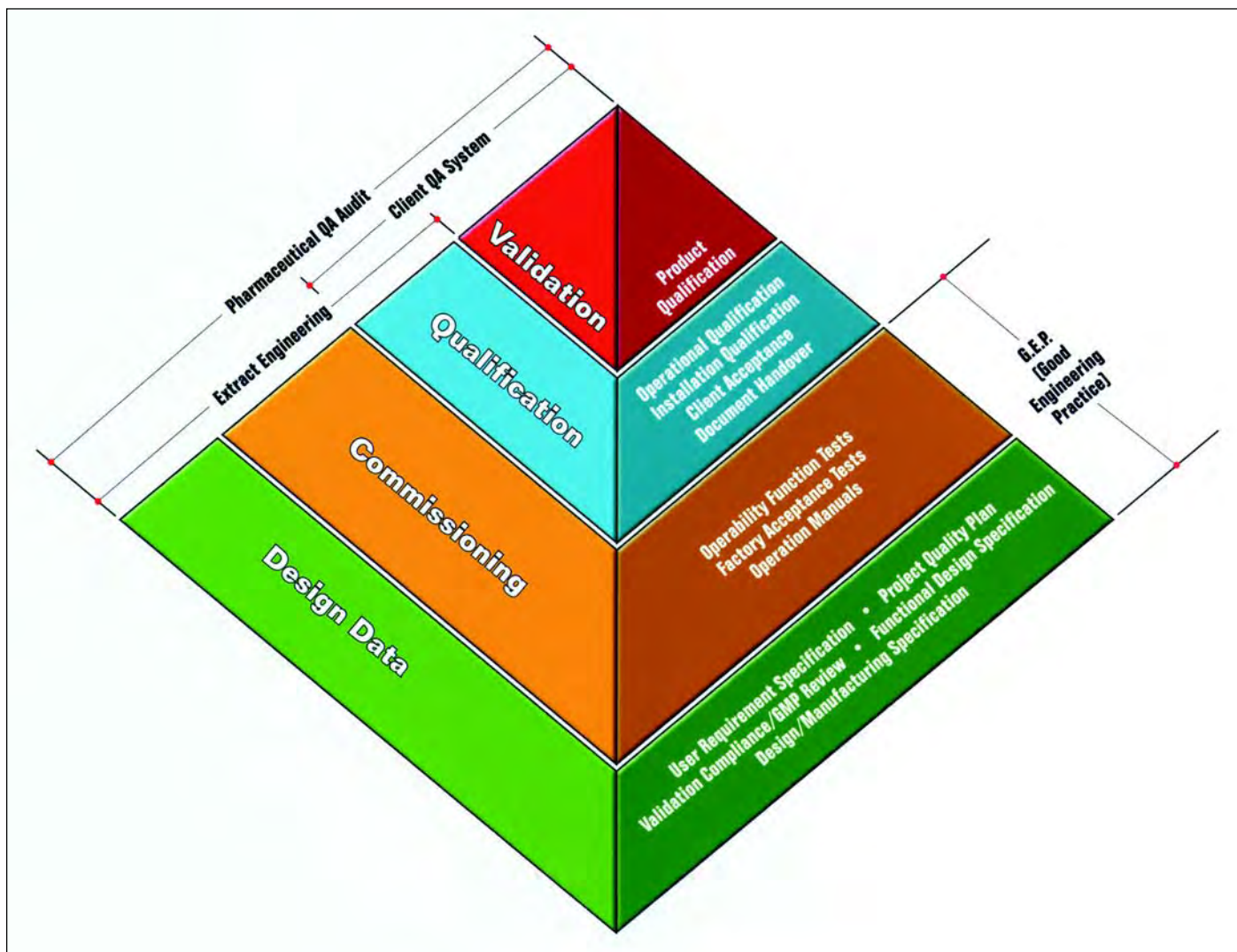

Figure 3. Compliance pyramid.

In short, there needs to be a clearly defined structure to which the Group operates and is controlled by. In the instance of the Technology Compliance Group, the 'Compliance Pyramid' was born - *Figure 3*.

### The Compliance Pyramid

Ownership and leadership are required throughout the design, commissioning, qualification and validation phases. Every facility and its equipment must be compliant. The compliance activities are often underestimated and this process of collation is complicated and worthy of leadership. Detailed procedures with tough requirements for detail and approval are implemented, but who owns the compliance process? Is this an item of delegated responsibility?

Within the equipment manufacturing phase of containment systems, multiple team members and the project owner assume primary responsibility for the compliance phase. Clear roles/responsibilities and accountability is vital for the project management control. Compliance is responsible for ensuring all inputs are received and documents completed correctly and on time.

Clear roles, ownership and the responsibility for leadership of compliance is within the project team. The equipment type/

size/location within the facility layout will be established to meet the project requirements, using the User Requirements Specification (URS).

Throughout the project life cycle, the following areas are critical to the role and responsibilities of compliance:

- Design Data
- Commissioning/Testing Data
- Qualification/Validation Data

### Design Data

The design documents produced in conjunction with the detailed design of the project are critical to compliance. The design data contains the detailed specification for all elements of the system to ensure the URS (User Requirement Specification) and FRS (Functional Requirement Specification) can be achieved. If a computer control system is involved, a separate FDS (Functional Design Specification) may be prepared for the computer system and will therefore be in accordance with GAMP 3. The FDS forms the basis for the DQ (Design Qualification).

### Commissioning /Testing Data

Commissioning/testing data comprise a number of documents requiring protocols for testing. Basically, the commissioning tests are carried out in the manufacturer's facility for customer approval prior to shipment and installation. The methods and acceptance criteria are all agreed upon prior to the tests. The tests and the level of documentation will be determined in the Validation Plan and depend upon the project. Where possible, these documents will form part of the IQ/OQ package. The computer system validation package will follow a similar profile under the GAMP format.

### Qualification/Validation Data

Formal independent qualifications of the system and, where a computer system is involved, is the point where the complete integrated system is validated. The protocols will therefore be determined by the complexity of the project. The protocols will comprise the rational, quality objectives and criteria, responsibilities, etc. written by the Compliance Group.

Restructuring the documentation life cycle within the company will give benefits in the following areas:

- Quality Plan
- URS
- Functional Requirement Specification
- QA Procedures
- GMP

#### Quality Plan

This is the top-level project control document to capture all the technical and contractual detail and to set the project policy and philosophy based upon the primary project documents.

#### URS (User Requirement Specification)

This document is prepared by the customer and the equipment manufacturer to capture all the actual user requirements i.e. GMP, operational, product, etc.

#### Functional Requirement Specification

This document contains technical details and specific functional requirements to prepare a specification which reflects the URS and engineering/technical requirements.

#### QA Procedures

These documents detail the QA requirements and objective rationale for the project. This leads to the preparation of the project validation requirements.

#### GMP

GMP is the part of the Quality Assurance system which ensures that products are consistently produced and controlled to the quality standards appropriate to their intended use and requirements of the Marketing Authorization. GMP is concerned with both production and Quality Control.

The interaction of documentation in the hierarchy can be compared with proposals being considered during the preparation of ISPE's Baseline® Guide on Commissioning and Qualification. Commissioning documents are covered within the ISO 9000 compliance regulations. Standard validation ISO 9000 documents are referred to by validation protocols that sit within the company validation policy. The development and monitoring of these documents are collated with the involve-

ment of different people within the organization i.e. Design Phase, Commissioning Phase, Qualification Phase and Validation Phase.

### Timing/Schedule

Compliance implementation within containment projects starts with the policy of documentation flow as outlined in Figure 4. A typical Compliance Project Schedule can be seen in Figure 5.

The URS is the first stage for compliance documentation. This is divided into three levels:

#### 1. Primary Project Documents

*First contact and client discussions.*

- User Requirements
- Functional Requirements Specification

#### 2. High Level Documents

*To be compiled immediately after the order, gaining project coordination.*

- Quality Plan
- Project Plan
- Validation Master Plan
- Project Documentation

#### 3. Functional Documents

*Base documentation to be generated at the project kick-off, propagated with the design criteria during the manufacturing phase.*

- Functional Design Specification
- Design Qualification
- Factory Acceptance Testing/Site Acceptance Testing
- Installation and Operational Qualification
- Validation Report
- Handover Certificate

A detailed schedule for the progress of the documents and buy-in by the project team (client and equipment supplier) is essential. The skills and the issues are not new and well within the tools available to the modern manager.

### Case Studies

#### Case Study A: Typical Downflow Containment Booth – Figure 6

A Downflow Containment Booth consists of: a structure forming an enclosure or room, ducting and fans to give an air circulation, a PLF grid to ensure a consistent even airflow, various filtration to give a high degree of particulate removal, and various controls (electrical and instrumentation) to ensure the maintenance of air pressures, temperatures, airflows, and on occasion humidity.

At the quotation stage, a Supplier Document Index is developed with the client listing all documents to be produced. This forms part of the basis for the Compliance Group's work. An example of this could be as follows:

#### Supplier Document Index

Contents:

1. Quality Plan
2. Technical Specification Functional Description
3. Contract Program
4. GA Drawing

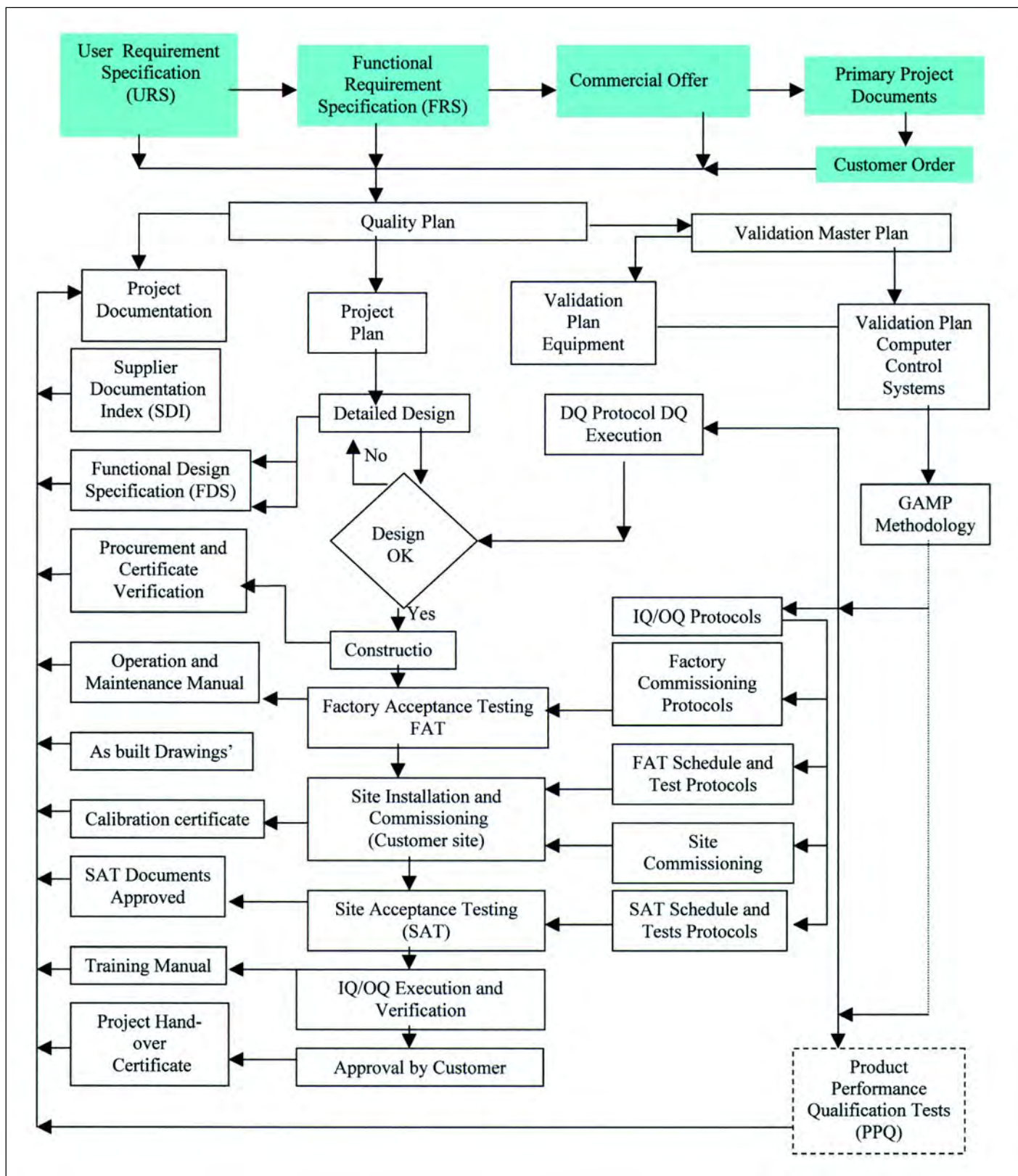

Figure 4. Project document and validation flow diagram.

5. Electrical Specification
6. O and M Manual
7. Commissioning Report
8. IQ/OQ Documentation

Design Qualification is the operation of assuring that the design meets the original users purpose and specification. This is ensured by preparing a URS (User Requirement Specification) for every contract. This is either provided by the client or is written by the vendor recording the clients' requests. A



Figure 6. Typical downflow containment booth.

typical index for the URS could be:

**User Requirement Specification**

Contents:

- 1.0 Introduction
- 2.0 Design Interview
- 3.0 Process Requirements
- 4.0 Layout/Service Requirements
- 5.0 Specific User Requirements
- 6.0 Validation Documentation
- 7.0 Service/Commissioning

<b><i>IQ CONTENTS</i></b>	
<b>1 Signature Record</b>	<b>4</b>
<b>2 Overview</b>	<b>5</b>
2.1 Objective	5
2.2 System Description	5
2.3 Scope	5
<b>3 Documentation &amp; Drawing Review</b>	<b>6</b>
<b>4 Drawing Checks</b>	<b>7</b>
4.1 Drawing Check (As Installed)	7
<b>5 Installation Review/Checks</b>	<b>8</b>
5.1 Service Requirements	8
5.2 Installation Requirements	8
5.3 Service Connection Checks	9
5.4 Booth Information Checks	10
5.5 Component Information Checks	11
5.6 Filter and Screen Checks	13
<b>6 Installation Qualification Exceptions And Further Actions Log</b>	<b>15</b>
<b>7 Installation Qualification Summary</b>	<b>16</b>
7.1 Interim Approval	16
7.2 Final Approval	16
<b>8 List Of Appendices</b>	<b>17</b>
<b>Appendix 1</b>	<b>18</b>
Marked-Up Drawings	18

Table A. Example index for booth's IQ documentation.

In response to this, a Functional Requirements Specification (FRS) and outline design drawing are prepared as part of the quotation.

Following an order, the outline design drawing is developed into a full General Arrangement (GA) drawing. It is the confirmation that the FRS and GA meet the requirements of the original URS that constitutes the DQ. A specific DQ protocol incorporating checkpoints has been developed to record the DQ activity. This DQ check parallels an internal design review or audit that occurs at the same time in one meeting to confirm the correct design.

Early in the project either the client's Validation Master Plan is received, or one is developed to coordinate the various validation activities.

Once the outline design has been developed, IQ and OQ protocols specific to the project are developed by the Compliance Group from the standard template. Templates have been created to apply to multiple designs for a given booth size. Examples of an index for the Booth's IQ and OQ documentation can be seen in Table A and Table B.

In conjunction with the basic booth, there also may be process equipment integrated within the unit, such as filling heads, and external to the booth there may be a facility created, such as airlocks and changing facilities. To the basic template for the booth IQ are added standard sheets covering such equipment and relevant architectural building features. These templates and standard documentation are owned and maintained as a library by the Compliance Group. It is important to establish items "critical" to the process and this will obviously vary significantly with the application. After discussion with the client, a risk assessment is developed to identify critical equipment – particularly instrumentation.

<b><i>OQ Contents</i></b>	
<b>1 Signature Record</b>	<b>4</b>
<b>2 Overview</b>	<b>5</b>
2.1 Objective	5
2.2 System Description	5
2.3 Scope	5
<b>3 Documentation Review</b>	<b>6</b>
<b>4 Instrumentation</b>	<b>7</b>
4.1 Requirements	7
4.2 Calibration Log Sheet	8
<b>5 Test No. 1</b>	<b>9</b>
5.1 Requirements	9
5.2 Results	10
<b>6 Operational Qualification Exceptions And Further Actions Log</b>	<b>11</b>
<b>7 Operational Qualification Summary</b>	<b>12</b>
7.1 Interim Approval	12
7.2 Final Approval	12
<b>8. Certificate Of Conformity</b>	<b>13</b>
<b>9 List Of Appendices</b>	<b>14</b>
<b>Appendix 1</b>	<b>15</b>
Calibration Certificates For Test Instruments	15
<b>Appendix 2</b>	<b>16</b>
Training Requirements	16

Table B. Example index for booth's OQ documentation.

During the construction and IQ execution, attention is then paid to calibration and testing of critical instrumentation against a fundamental standard.

All equipment is assembled in a fully working form at the factory. Where multiple identical pieces are required, it may be only one example of a type. These are then subjected to a pre-qualification check and testing (Build Run Test) to ensure they meet their basic performance requirements, particularly any specifications for containment. Typical tests would include fan vibration, air pressures and flows, power requirements etc., but where an occupational exposure level is specified, they also may include testing with a simulated powder operation and measurement of resulting dust levels. Standard procedures are available for these tests and are used as the basis for the qualifications. This Build Run Testing is documented as a Pre-Delivery Inspection Document. It has been developed to meet the requirements of ISO 9001 and is carried out for all projects except pharmaceutical projects since they require validation and design documentation requirements. Along with for example the design documents. It forms part of the fundamental basic level of good engineering practice as described in Figure 3. For a pharmaceutical project, these tests constitute the Factory Acceptance Test (FAT).

In general, all booths are then disassembled, transported to site and re-erected. It is then typically at site that the IQ checks for completion to design, and OQ of operating performance are completed, and the documentation is finally approved. One exception is the PharmaSpace module where the whole booth is built in the factory as a volumetric building element and transported to site without alteration. As most of the PharmaSpace modules only involve site connection of an

electric supply, it means that the IQ and part OQ can be completed at the factory. Only a final check is required at site.

#### Case Study B: High Containment Barrier Isolator - Figure 1

An isolator or glovebox typically consists of two or three interconnected chambers with different air regimes and with access via gloves to the operations. A typical operation may be dispensing to small containers or Intermediate Bulk Containers (IBCs). A keg is placed into a loading chamber, the door is closed and it is lifted against a bulkhead and inner door. The door is opened to allow material to be removed into the handling chamber where it is weighed and discharged down a chute to a local container or remote IBC.

In general, the qualification follows a very similar route to that described in Case Study A for a booth. However, there are two major differences.

1. Isolators generally have a more complex series of airflow/pressure relationships (note for example 3 compartments instead of 1), can be nitrogen inerted, and may have complex container handling. Frequently, this will require the use of Programmable Logic Controller (PLC) control. For example, the control of nitrogen inerting may be fundamental to the product quality, "critical," and therefore the PLC operation needs to be qualified to GAMP standards. This is not common. More commonly there is a requirement to meet "black box" requirements. Either result is an extensive subset of documentation for which there will be developed protocols based upon the use of our standard procedures. Use again is made by the Compliance Group of standard

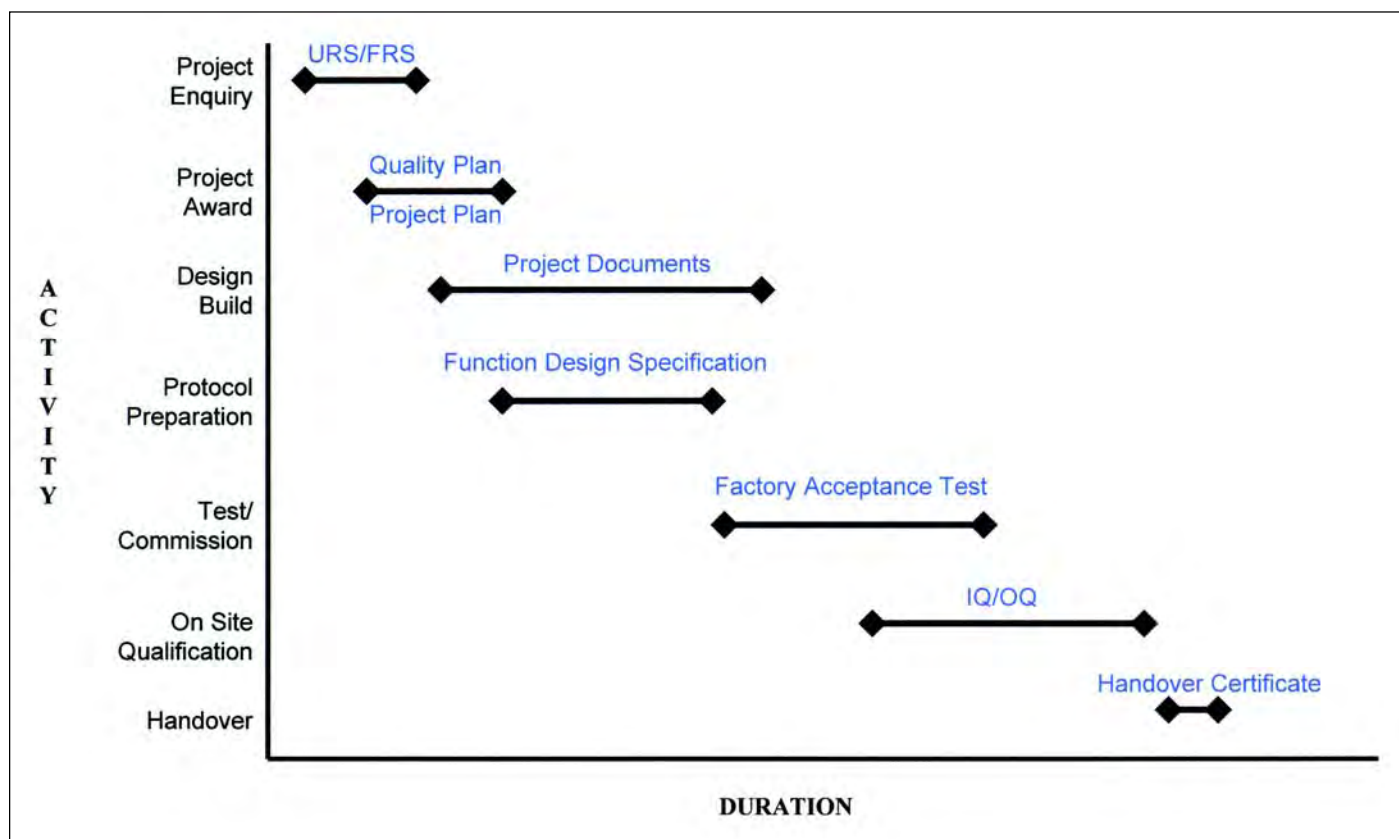

Figure 5. Typical compliance project schedule.

Benefits of Compliance "A Single Focused Group"	
Description	Benefit
Control	Efficient Operation
Preparation of the specification (Project URS)	Sound foundation
Using the company knowledge and clarify the scope of the project	Everything clearly seen improved communication
Discussing with Customer	Single point contact
Auditing the supplier and sub-contractors	Clear understanding
Defining the boundaries for qualification/validation	Common knowledge and agreement
Preparing the Quality Plan	Co-ordination and planning
Preparing the Validation Plan	Co-ordination and planning
Preparing and issuing the Documentation on time	Right first time. Maintain project schedule
Design Qualification	Building on sound foundation

Table C.

templates modified to a specific project requirement.

- Isolators frequently have Clean-in-Place (CIP) systems. While it is not possible to test at the factory on the client's materials, tests are carried out to prove that this frequently custom equipment meets the cleaning validation criteria. This would typically be done using an operation of fine paracetamol (acetaminophen). Swab testing at various sites is undertaken and analysis at various stages e.g. pre-wash and clean. Again, all relevant documentation is collated into the project qualification file.

### Benefits of Compliance

Understanding GMP/compliance requirements ensures understanding of 'fitness-for-purpose' and responsibilities. Understanding 'fitness-for-purpose' enables quality to be built into the design, installation and operation of the equipment. Building in quality (design and methodology) ensures the equipment and installation are right the first time.

The pharmaceutical industry can sometimes see delays as high as 30% of the original schedule when compliance documentation is not issued in an orderly manner. This impact is not tolerable for the introduction or product launch or contract manufacturing obligations. More pressure is on the project to keep schedule dates and importantly the equipment supplier to deliver the equipment and documentation.

The benefit externally is a greater understanding and control of the project by the following:

- demonstration of the understanding of the concept and principle of the project and compliance requirements
- understanding of the customer user requirements
- by designing, specifying and installing a qualified system and protocol
- knowing its purpose and operational requirements in the total project and operation

- person who knows the equipment is designing an appropriate protocol
- benefits internally to the company and externally to the client are that under a single focused group the activities are controlled and developed jointly. See Table C.

These help to manage and control the documentation throughout the project life cycle, bringing the concept together for "Right First Time."

The key objectives of the Compliance Group are to:

- design and specify the product in accordance with the current regulation
- improve and modify designs to meet different GMP applications
- provide one system that meets all objectives, ISO 9000, cGMP etc.
- improve interfaces internally and externally

### Summary

Compliance practices have excellent value and are a solid foundation on which pharmaceutical companies can build. Manufacturers and suppliers of containment systems are looking for economy and speed in their implementation of projects. This can be achieved by a good organized compliance structure. Bringing a compliance team together in one group improves the awareness and realities needed by vendors and manufacturers to move towards an efficient system. Improved project management and compliance, including meeting GMPs, can be accomplished with the existing skills and tools available today. The pharmaceutical industry is challenged to improve quality and compliance in the new millennium.

### References

- Cocker, N., "Vale III Isolation Validation - Guaranteed Protection," Pharmaceutical Engineering, Vol. 19, No. 5, 1999, pp.24-34.
- United States Code of Regulations Title 21, Parts 210 and 211 concerning Current Good Manufacturing Practices for Finished Pharmaceutical.
- FDA Guideline on the General Principles of Process Validation, 1997.
- European Directive 91/356/EEC concerning Good Manufacturing Practices for Medicinal Products in the EC, Vol. IV.
- ISPE, GAMP 3 Supplier Guide for the Validation of Automated Systems in Pharmaceutical Manufacturing, 1998.

### About the Authors

**John Nichols** is the Engineering Director for Extract Technology. Previously, he was manager of pharmaceutical technology for Foster Wheeler Energy Ltd. with particular responsibility for technical direction and support to various pharmaceutical facility projects worldwide, for nearly 20 years. His current role involves the development and progressing of strategies for the realization of new products and contract implementation. It also includes advising clients on implementing appropriate materials handling and containment solutions for a wide variety of facility types. Nichols is a



chemical engineering graduate with a diploma in management, a Fellow of the IChemE and a member of ISPE's European Education Committee.

**Stuart Preston** is the Technology Compliance Group Manager for Extract Technology. He previously worked for Kvaerner Process as a project manager and gained several years experience working on overseas projects. He has 15 years of experience in the pharmaceutical industry. His current role is to develop and implement compliance and quality. Preston is a mechanical engineer and is a member of IChemE, the Institute of Management and ISPE.

Extract Technology Ltd., Bradley Junction Industrial Estate, Leeds Road, Huddersfield, West Yorkshire HD2 1UR United Kingdom. 

This article defines a technical program document and provides details on what information this document should contain. Specific examples on how to save time and money on the project site as well as the benefits of creating a technical program document to present the project to regulatory officials are given.

# Heightening the Success of a Project Through the Use of a Technical Program

by Julie-Lea Lipszyc, Costa Nicolainas, Isabel Piraux and Martine Rondeau

## Introduction

**A** technical program is an effective document that helps simplify the design, construction, commissioning and validation of equipment, a process or facility. The management of information during the design, construction, start-up and commissioning of a facility or project dramatically impacts the success of each of these project stages. With the escalation of construction, expansion, restoration and equipment installation projects in the pharmaceutical and biotechnology industries, effective tools which simplify the administration of information throughout all project stages can ensure that expected schedules and costs will be met. Based upon the defined process requirements, the project technical program is a document that can be used by the company, architects, engineers, contractors and/or equipment manufacturers to transfer and retract critical information and eventually as a document to support the compliance of the project to the regulatory authorities. In effect, the technical program can become the framework for all other conformity documents required for the project. Within the industry, the use of a technical program has proven to be efficient in many case studies, particularly in problem solving and rapid decision-making situations involving the various people implicated in the project.

This article details how the technical program is integrated within each stage of a project and shows how creating a technical program based upon preliminary or well defined manufacturing processes provides the ideal condition for easily starting the document as well as for the final success for the project. Guidelines for the type of information that should be found in the document are provided as well as who in the project team should create and manage the technical program to maximize its effectiveness for project planning and quick decision making. The implementation of the technical program during the design, construction, commissioning

and validation of a production or research facility or expansion will similarly be developed.

## Key Information - The Heart of the Technical Program

A technical program's structure should provide a general standard listing of the characteristics for every room, area or zone that are already defined and outlined for the new or existing facility. The goal of the technical program is to gather pertinent architecture, equipment and environment information and present it on an area-by-area basis. Each of the general characteristics defined for these facility areas should then be elaborated, thus providing detailed information specific to the anticipated application of the facility.

The basis for the technical program thus reflects the needs of a single process or a multitude of processes expected for the project, while taking into consideration the regulatory requirements. Though the exact layout of a technical program is not critical, its content is significant and success in using a technical program can be increased by creating a document with a clear and concise format. Figure 1 shows a possible technical program layout and typical information that should be found in it. Information extracted from a real life project is included to illustrate the detail of the facility design data that should be found in the program.

The following sections characterize in greater depth the rationale behind the various parts of a technical program and provide specifics on information that each part should contain, keeping in mind the focus on architectural, equipment and climate control needs of each production process located within the various defined areas of the facility.

## Defining Your Architectural Needs

The prime objective of presenting information in this part is to ensure that each room of the facility conforms to the specifications needed by

the process and similarly represents an area that will meet the level of cleanliness required by the industry and the company. Key architectural data that should be found in the program includes, but is not limited to, room dimensions, finishes, information on doors, windows, light, pass-through, sinks, fixtures, access restriction, security, furniture and drains.

Defining the exact dimensions of a room ensures that an adequate work space has been allocated and allows ventilation calculations to be made during the design stage. Floor, plinth, wall and ceiling finishes are defined according to the required classification and utilization for the room. Smooth, washable finishing materials should be specified for classified rooms while conventional building materials (painted walls, acoustic tiles, tiled floors, etc.) should be specified elsewhere. The number of doors and windows in each room, as well as their construction material and required airtightness, also should be detailed.

Lighting types, lighting frame types (sealed or non-sealed) and quantity of fixtures should all be defined, depending upon the classification of the room, in order to preserve the pressure integrity of the room.

Typical sink types (counter top, mop sink or hand wash station) and their finishes, as required for the process and personnel operations, should be allocated a section in the program. Also, drain sizes and types (contaminated, non-contaminated or sanitary) must reflect the needs and capacities requested by the chosen sink types, and must consider any hazards that are presented by each particular waste product.

Furniture descriptions (type, size and construction material) for laboratories and production areas, should be included.

### **Make Sure the Right Equipment will be Installed Correctly**

Choosing equipment types and capacities at earlier stages of a project is not always easy since process definitions are often continually evolving. Regardless, equipment should be defined based upon first approximations in order not to interfere with the advancement of the facility and/or project at any point. General information on equipment such as manufacturer, model, dimensions, capacity and heat loss to the room as well as equipment location (room, counter or floor, fixed or mobile, etc) is needed and updated throughout the project lifetime. Additional equipment information which is useful for design and management purposes, that should appear in this section, include equipment utility requirements (pressures, consumption rates, temperatures and connection sizes), purchase status, weight and delivery dates.

### **Know Your Environment**

The technical program is a platform for outlining the characteristics of the ventilation system since critical information such as room cleanliness, confinement, air change rates, air supply velocities and particle counts must be identified, especially at early stages, for any HVAC modification or installation project. Rooms or departments requiring higher classifications due to the type of materials handled may require that independent ventilation systems be dedicated to the area. Identification of the various systems found in the technical program therefore should be made. Given that either regulatory specifications or company internal specifications are used to determine the necessary parameters, it is good practice to also list reference comments in the program. Room temperature specifications and acceptable ranges for temperature

control should respect product sensibility, room classification, seasonal changes and operator comfort.

Another very important section of a technical program is the listing of all equipment and systems related to communications, safety and security. Here, all door interlock systems, access systems, emergency opening buttons, gas detectors, thermal detectors, sprinklers (including type), telephones (clean type or not), printers, bar code outlets and data collection systems should be identified. Such information becomes quite useful during the commissioning phase of the project since check lists can easily be generated from this information.

Once the structure of a technical program has been defined, information will continually be entered and updated throughout the design, construction and commissioning phases of the project. Advantages in using this approach will be discussed in greater detail for each phase below.

### **Conveying the Process and Facility Design to Everyone**

As is common today, the design and planning stages of a facility apply not only to new constructions, but also to facility expansions, the installation of additional process lines as well as optimizations within existing facilities which seek cGMP compliance. The creation of the technical program can play a key role in ensuring that the design work is started, developed and completed successfully and, more importantly, meets the intended needs of the project. In this respect, the technical program should be produced at the earliest possible stage of the project, when the basic criteria for the project are defined. The technical program should then be integrated in the preliminary design process, to present information in a concise and orderly form that enables both architects and engineers to issue the preliminary project plans and costs. It should be a link between the wanted process and the facility that will service the process. At this stage, the program reflects, to a large degree, the quantity and type of equipment that will be in place as well as the capacity of the services and the room characteristics. During the design stage, even though the process may be developing, preliminary estimates of equipment types and sizes should be entered in the program in order not to slow down the design on the facility side.

As the preliminary architectural and mechanical plans evolve and are revised, so should the technical program enabling a synergy to form between the plans and the data found in the program to ensure that no information has been overlooked. In effect, its development and application during the design can shorten the time required to finalize this work and help to better coordinate the start of the project construction and/or installation phases. Advantages to such an approach which uses the program include the "quick and easy:" 1) dissemination of information from the equipment manufacturers to the design professionals, 2) retraction of information by the designers and users when required and 3) presentation and transfer of information between the professionals working on the project.

Processed information that should be found when possible at this stage includes equipment descriptions, locations, sizes, utility requirements, electrical requirements and heat rejections. Although assumptions must be made, particularly for major equipment when dealing with a developing process, the bulk of the entered equipment information should at least be confirmed by equipment manufacturers, even though equipment designs/plans for user approval are usually not issued at

this stage. Also, operational requirements of the process, such as the need to wash hands before entering a production zone, process waste decontamination needs, and room temperature and pressurization specifications, should all be included. Information should be verified during the preliminary design; this will minimize false data which can lead to oversights during construction, time losses and difficulties in the subsequent equipment or service start-up phases.

### **Simplifying On-Site Decisions**

Normally, most specifications are reflected on drawings and documents prepared for tenders and/or for construction projects. However, interpretation and transfer of information in these formats may not be familiar to everyone involved in the project. Difficulties often arise due to the different levels of understanding of the various people involved. For example, professionals involved in mechanical and electrical construction, though proficient with these types of plans, may encounter some dilemmas in interpreting process flow diagrams. Similarly, end users are not always familiar with technical construction plans and formats, and sometimes are unwilling to review this information.

It is also common that some of the multiple contractors involved in the project may have very little or practically no experience related to the pharmaceutical and biotechnology industries. Therefore it is difficult for them to pre-anticipate any problems that may arise related to particular construction techniques or requirements of the industry. Lack of comprehension or misunderstanding of such information can lead to delays and heightened project costs.

The technical program as an up-to-date reference document minimizes the possibility of transferring partial documentation or transmitting wrong versions of documents. Thus, the various changes that occurred or were necessary during the construction phase, as compared to the initial design, can be tracked enabling subsequent analysis of these results. It becomes an effective tool for any project manager needing help to allocate contracts to the various companies, to accelerate decision making and to simplify planning in general.

### **Allocation of Contracts**

By simplifying the verification of multiple plans and reducing errors and/or omissions during the requests for proposals, the time required to establish tenders and contracts can be shortened. Also, prior to commencing construction, it is advantageous to have all the proposed materials of construction presented in a condensed format which can reduce ordering oversights and mistakes. Consequently, general contractors should be given the program as early as possible since the financial aspect of the project construction is directly related to the quantity and quality of utility components and building materials required. For example, epoxy coated floors versus standard vinyl tile floors, the required number of doors and windows, the quantity of HEPA filters and ventilation ducts, are all significant in varying the project cost. Contractors should provide comments to the program since supplementary costs are accrued when ordering additional materials (for example a single door) rather than having purchased all material types at the same time.

### **Decision Making**

Often multiple factors arise on site, such as shipping delays, errors in purchasing building material quantities, time delays

and other unforeseen circumstances, along with the need to intermittently reduce construction costs. When considering all these factors, quick reference to decision-making data is essential, and consequently any changes or decisions made must be entered in the technical program to reflect the project as-built.

### **Planning**

Successful projects are based without any doubt upon successful time frames and costs established and allocated for construction, and thus planning well-orchestrated installations remains probably the most important element of the project. Consequently, planning should cover the purchasing and installation of architectural components, utility services and process equipment. The lists developed in the technical program should be used to generate time scheduling and resource allocations for these activities as well as for other commissioning and calibration duties. For optimal results, it is important to identify in the program rooms that must be sequentially completed over others in order to coordinate the installations of HEPA filters and equipment that are to be integrated into the building structure. Wise planning during construction will allow an optimization of the subsequent commissioning phase.

### **Commissioning and Start-Ups with Technical Program in Hand**

As in previous steps, the technical program in commissioning is helpful in determining the chronological aspect of starting systems while keeping in mind eventual priorities for production.

Consequently, during fast track start-ups executed under tight schedules, a start-up team operating with minimal resources can leverage upon the technical program so as to transfer needed information to complete each task. The following sections are good examples of how the technical program can help during the start-up of critical systems.

### **Utilities**

Before starting priority production equipment, all necessary services must have been commissioned, and a decision should have been made regarding the demand for all the other points of utilization of the same service - *Figure 2*. For example, pure steam required by a steam sterilizer must conform to required specifications, as outlined in the technical program. If other equipment is to be added to the same steam distribution line, an evaluation of the impact on the pure steam supplied to the sterilizer also must be evaluated before the start-up.

### **Medical Gas Distribution**

Targeting gas utilization points, room by room, allows the commissioning team to rapidly detect on-site all deficiencies which have not been detected during the construction phase. It also permits a verification of security devices such as gas detectors and alarms that should have been anticipated and installed as planned or as required by the safety regulations.

### **Purified Water Production and Distribution System**

References provided in the program on the quantity, size and location of each water utilization point help installation teams easily identify and relate valves to each distribution network in order to produce checklists for passivation purposes. Commissioning teams can at the same time easily verify that the proper valves and piping have been installed for each distribution network.

**Company name**

**Room Name and Number**

<b>Treatment Laboratory</b>	<b>819</b>
-----------------------------	------------

<b>DIMENSIONS</b>	<b>819</b>
Height	: 2,450 m (Max.)
Width	: 5,58 m (Approx.)
Length	: 9,43 m (Approx.)
Surface Area	: 52,6 m <sup>2</sup> (Approx.)
Volume	: 128,92 m <sup>3</sup> (Approx.)
Remarks	: None

<b>FINISHES</b>	<b>819</b>
Floor Material	: Concrete
Floor Finish	: Seamless vinyl sheet
Wall Material	: Gypsum
Wall Finish	: Epoxy coating
Plinth Material	: Vinyl, rubber
Plinth Type	: Round corner
Ceiling Material	: Gypsum
Ceiling Finish	: Epoxy coating
Remarks	: None

<b>DOORS</b>	<b>819</b>
Door Number	: 7
Door Type	: F
Thickness	: 45 mm
Width	: 60-915 mm
Height	: 610-915 mm
Height	: 2 032 mm
Material	: Press wood, masonite
Finish	: Epoxy coating
Door Hardware	: Door seal/ electromagnet
Window Size	: None
Window Type	: Not applicable
Remarks	: Between room 819 and 818

<b>WINDOWS</b>	<b>819</b>
Sanitary Edge	: No
Glass Type	: Clear & tempered glass (6 mm)
Frame Width	: 940 mm
Frame Height	: 2 080 mm
Frame Material	: Steel cal. 16
Frame Finish	: Epoxy coating
Frame Detail	: None
Frame Rating	: Not available
Hardware No.	: None
Remarks	: To see in room 822

<b>ROOM &amp; EQUIPMENT UTILITIES</b>	<b>819</b>
Location	: Room air recirculation (HVAC-10)
Utility	: Glycol
Qty. of Connections	: 2
Type of Connection	: Threaded
Connection Size	: 25 mm
Pressure	: 241,3 kPa
Consumption	: 0,19
Consumption	: Liter per second
Remarks	: Located in interstitial ceiling space

<b>FURNITURE</b>	<b>819</b>
Furniture	: Counter on legs
Material	: Acid resistant top
Size (HxWxD)	: 13700 mm X 730 mm
Type	: Drawers under sink
Qty.	: 1
Remarks	: Melamine sides
Furniture	: Cabinet with drawers
Material	: Melamine with acid resist. top
Size (HxWxD)	: 500 mm X 605 mm X 660 mm
Type	: Mobile
Qty.	: 2
Remarks	: None

<b>GENERAL EQUIPMENT</b>	<b>819</b>
Equipment No.	: F-193
Description	: Laboratory Freezer (-30°C) DD
General Remarks	: None
Manufacturer	: ABC Freezers, Inc.
Model	: MD-2099
Status	: Final
Dimensions (WxDxH)	: 804 mm X 775 mm x 1800 mm
Weight:	: 118 kg
Floor or Counter Top	: Floor
Fixed or Mobile	: Fixed
Heat Loss	: 760 BTU/hr (Approx.)
Capacity (hp)	: Not available
Remarks	: None

<b>GENERAL EQUIPMENT (CON'D)</b>	<b>819</b>
Equipment No.	: A-103
Description	: Autoclave
General Remarks	: None
Manufacturer	: Steam Technologies
Model	: 5000 C
Status	: Final
Dimension (WxDxH)	: 660 mm X 870 mm x 520 mm
Weight	: 79 KG
Floor or Counter Top	: Counter top
Fixed or Mobile	: Fixed
Heat Loss	: Not available
Capacity (hp)	: Not available
Remarks	: None

<b>COMMUNICATION &amp; SECURITY</b>	<b>819</b>
Communication Devices	: Humidity Sensor
Number of Devices	: 1
Remarks	: Located in room

<b>LIGHTING</b>	<b>819</b>
Level	: 70 fc
Lamp Type	: Fluorescent (2 lamps T8)
Frame Type	: Built-In
Frame Finish	: Baked white enamel
Power	: 32 W each fluorescent
Control	: Switch
Electrical Supply (Volts)	: 347
Remarks	: 16 fluorescents in the room

<b>TEMPERATURE</b>	<b>819</b>
Temp. setting	: 22°C
Temp. variation	: 20-23°C
Humidity setting	: 55%
Humidity variation	: 35-70%
Remarks	: None

<b>AIR SUPPLY</b>	<b>819</b>
Diffuser Dimension	: 1 200 mm x 600 mm
Flow Rate feor Diffuser	: 175 L/s
Filter Type	: HEPA
Frame Finish	: Anodize aluminium
Remarks	: Recirculated air

<b>AIR EXHAUST</b>	<b>819</b>
Vent Size	: 600 mm X 600 mm
Air Flow Rate	: 320 L/s
Temperature	: Not applicable
Exhaust Vent No.	: 1-E
Location (height)	: In the interstitial space
Remarks	: Air taken from recirc. plenum

<b>ELECTRICAL EQUIPMENT &amp; RECEPTACLES</b>	<b>819</b>
Equipment No./Spare	: F-193
Capacity	: 480 W
Normal / Emergency	: Emergency
Voltage	: 120 V
Amps	: 15 A
Receptacle Type	: Duplex
Location /Height	: 400mm
Connection	: Plug
Wire	: 1 Phase
Breaker No.	: E-3045
Breaker size	: 15A
Remarks	: None

<b>VENTILATION DESIGN</b>	<b>819</b>
Classification	: 100 000
Biosafety level	: None
Min. Required air changes	: Minimum 20 air changes/hour
Pressurisation	: 0,25 in H20 vs room 825
Positive to Room	: 818 A
Negative to Room	: None
Remarks	: None

<b>AIR RETURN (RECIRCULATED)</b>	<b>819</b>
Vent Size	: 600 mm X 600 mm
Design air Flow Rate	: 350 L/s (% is exhaust)
Location (height)	: Ceiling
Frame Finish	: Aluminium
Frame Type	: Grate
Remarks	: Grate no G-2

Figure 1. Technical program layout partial example.

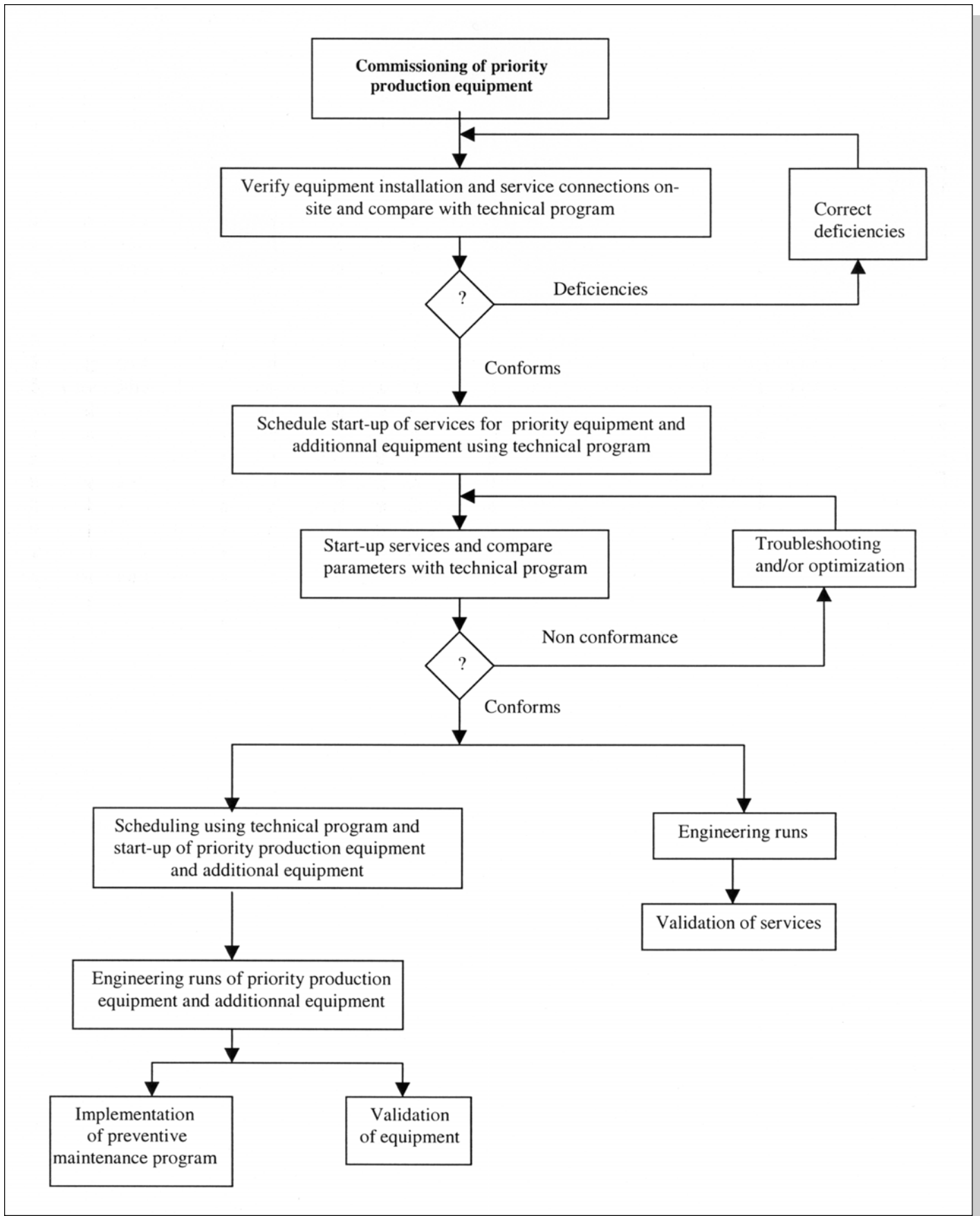

Figure 2. Commissioning of priority production equipment.

## HVAC Systems

The use of the technical program during the start-up of HVAC systems is effective mainly for balancing ventilation systems, verification of room and department pressurizations and when adjusting room temperature and humidity settings. Balancing test results can be compared with specifications found in the technical program to produce balancing reports during commissioning. Similarly, other commissioning reports such as HEPA filter integrity, temperature and humidity stability and HVAC system capacity requirements can be generated by referencing the technical program.

The comprehensiveness of the technical program during start-ups allows the planning of engineering runs, verification of required utility services, installation integrity and the detection of installation mistakes. Clearly, as the project moves through its design, construction and commissioning phases the next step is to use the information of the document during the validation, operation and preventive maintenance programs that will be implemented. Particularly, information needed for validation protocols can be easily found in the document and, as with commissioning schedules, validation schedules can be based around the utility service and equipment lists that can be created using the technical program.

### A Complete Account of the Project

Even though the technical program will be structured to reflect the particular needs of the project, it should nonetheless fulfill the compliance requirements of a quality cGMP document in regards to its pre-defined format, review and control. One prerequisite is that three key personnel should be identified in a compliant technical program: the author, the reviewer and the approval officer. Evidently they should be implicated in all facets of the project in order to ensure that the data is reviewed and changed by authorized people who are up to date with developments of the project. Information that cannot be directly or personally confirmed by the reviewer, for example, should be accredited by the reviewer requesting certificates from the pertinent companies (contractors) that provided the data. Similarly, the technical program's distribution must be controlled, and only the final approved version should be circulated by a mandated individual.

With this in mind, technical programs can be presented along with site reference files as complete regulatory documentation packages, which portray a tangible reflection of the compliance of the project put in place, particularly showing the quality of the facilities, installations, equipment and the utility services.

The contents of a well-structured document enable the facility not only to respect cGMP requirements, but other quality assurance regulations such as ISO 9000, notably supporting the sections which stress the need for controlled environmental conditions for production (§ 4.9, ISO 9001:1994).

### Conclusion

The underlined strength of the technical program is the ability to present the information in a simple format in order to save time and meet project budget and end result objectives. The facility profile drawn by the technical program is as accurate as possible and confirms the compliance of the facility since the program follows its evolution from the initial design stage to the final validation.

As such, the technical program should not be considered as an additional document which needs to be produced, but as a

structural platform for accomplishing design, construction and commissioning and for meeting regulatory requirements. In this way specifications from both the company and from regulatory authorities can be met and presented.

### References

1. "Study Course for Certified Testing of Clean Rooms," National Environmental Balancing Bureau, 1989.
2. "ASHRAE Applications Handbook," ASHRAE, 1995, Chapter 15.
3. Levenhagen, J., "HVAC Controls and Systems," McGraw-Hill, 1993, pp. 297-299.
4. Wheeler, W., "Commissioning: A Vital Precursor to Validation," *Pharmaceutical Engineering*, July/August 1997, pp. 50-52.

### About the Authors

**Julie-Léa Lipszyc** is a Quality Specialist at Validapro Inc. She is involved in coordinating regulatory requirement and validation efforts of clients and has implemented various structures dealing with cGMPs and ISO 9002 for national and multi-national clients. She has conducted many cGMP audits of suppliers and manufacturers and provides training courses on a multitude of regulatory and validation issues. She has a Master's in quality assurance for pharmaceutical, cosmetic and dietary products from Paris, France.

**Costa Nicolainas** is an Engineer at Validapro Inc. He provides design, construction, commissioning and process expertise to the firm's wide range of clients and is implemented in coordinating projects prior to their operation and subsequent validation. He has more than eight years of experience in the pharmaceutical and healthcare industry involving work in design, engineering, production and quality assurance. He has a BS in chemical engineering from McGill University and is a member of ISPE and the Quebec Order of Engineers.

**Isabel Piraux** is an Engineer at Validapro Inc. She is involved in project management and in the commissioning and construction of large scale pharmaceutical and biotechnology facilities both in Europe and North America. She provides HVAC and other large equipment technical specification expertise to clients seeking regulatory compliance. She has a Bachelors in civil engineering from Laval University and is a member of the Quebec Order of Engineers.

**Martine Rondeau** is an Engineer at Validapro Inc. She has been involved in the commissioning of large scale steam, cooling water, purified water and compressed gas systems for pharmaceutical companies in both Europe and North America. She provides engineering support for the validation of such systems as well as for other production and containment validation requirements of clients. She has a BS in chemical engineering and microbiology from Laval University and is a member of the Quebec Order of Engineers.

Validapro, Inc., 2 Place Laval, Laval, Quebec H7N 5N6 Canada. [www.validapro.com](http://www.validapro.com) 

This article presents two Content Uniformity Examples and provides the bases and minimum process capability formulas for other USP-based process attributes including Degradant, Impurity and Single-Point Dissolution. The purpose of this article is to provide scientifically sound tools to the reader for use in determining whether or not a manufacturing process is statistically capable.

Reprinted from  
PHARMACEUTICAL ENGINEERING

The Official Journal of ISPE  
March/April 2000, Vol. 20 No. 2

# Process Validation - Establishing the Minimum Process Capability for a Drug-Product Manufacturing Process (Part 2 of 2: Content Uniformity Examples and Extension to other USP Tests)

by Dr. Paul G. King

## Introduction

In the previous article,<sup>1</sup> the abstract quality concepts known as Process Capability ( $C_p$ ) and Process Capability Index ( $C_{pk}$ ) (which have begun to be used to assess the performance capability of a pharmaceutical drug-product manufacturing process<sup>2,3</sup>) were applied to the validation of pharmaceutical process steps using protocols that only test a few batches, typically three. In the previous article, the concept of minimum process capability was introduced

and its validity for use in the validation of pharmaceutical process steps was established.

The purpose of this article is to provide scientifically sound tools to the reader for use in determining when, based upon its minimum capability, a manufacturing process is statistically valid as well as assessing the quality of that process based upon the results obtained from the study of a few production batches. For simplicity and to mesh with other published drug product examples, the examples used in this article are based upon data from finished tablet studies.

This second part presents two tablet content uniformity examples. In addition, it provides the bases and minimum process capability formulas for other USP-based process attributes including degradant, impurity, and single-point dissolution.

For those that do not have access to the first article, the fundamental "minimum process capability equations" that were established in the first part of this two-part publication are presented in Figure 1.

For "minimum process capability," Equation 1 was established for the case where the appropriate predetermined upper and lower limits must be used, and Equation 2 was established for use when it is valid to use a predetermined upper limit and predetermined target approach. In all cases, "P" is the percentage value found using the appropriate statistical nomograph<sup>4</sup> that provides the percentage uncertainty in the variability computed from a given representative test set of articles at various confidence lev-

### Equations

$$C_p^*(factor) = \frac{(\text{Upper Limit} - \text{Lower Limit})_{factor}}{[6 \times (1 + "P"/100) \times (s_p)]} \quad (1)$$

$$C_p^*(factor) = \frac{(\text{Upper Limit} - \text{Target})_{factor}}{[3 \times (1 + "P"/100) \times (s_p)]} \quad (2)$$

$$C_p^*(CU) = \frac{(115 - \text{Target})_{CU}}{[3 \times (1 + "P"/100) \times (s_p)]} \quad (2a)$$

$$C_{pk}^* = \text{Minimum of the set } |C_{p\text{ Upper}}^*, C_{p\text{ Lower}}^*| \quad (3)$$

$$C_{p\text{ Upper}}^*(factor) = \frac{(\text{Predetermined Upper Limit} - PM_{ULE})_{factor}}{[3 \times (1 + "P"/100) \times (s_p)]} \quad (3-1)$$

$$C_{p\text{ Lower}}^*(factor) = \frac{PM_{LLE} - \text{Predetermined Lower Limit})_{factor}}{[3 \times (1 + "P"/100) \times (s_p)]} \quad (3-2)$$

$$PM_{ULE} = \text{Process Mean} + [t_{(1-0.01/2, n-1)} \times S_{\text{Mean}}/\sqrt{n}] \quad (3-1a)$$

$$PM_{LLE} = \text{Process Mean} - [t_{(1-0.01/2, n-1)} \times S_{\text{Mean}}/\sqrt{n}] \quad (3-2a)$$

where:

n is the number of individual batch mean values average to obtain the process mean value (in PQ, "n" must minimally be three, while some study up to 10 lots);

$s_p$  is the sample standard deviation computed from the individual batch means and the process mean value; and

$t_{(0.995, n-1)}$  is the t statistic found in a suitable table of the "Percentiles Of The t Distribution" for n-1 degrees of freedom (df) at the 99.5-% confidence level.

$$C_{pk}(CU) = \frac{(115 - \text{mean obs.})}{[3 \times s_{\text{Pobs.}}]} \quad (4)$$

Figure 1.



NUMBER OF BATCHES (n)	$t_{(0.995, n-1)}$ (see Reference 4)	CORRECTION MULTIPLIER $t/n$
3	9.925	5.730 <sub>2</sub>
4	5.841	2.920 <sub>5</sub>
5	4.604	2.058 <sub>9</sub>
6	4.032	1.646 <sub>0</sub>
7	3.707	1.401 <sub>1</sub>
8	3.449	1.219 <sub>4</sub>
9	3.355	1.118 <sub>3</sub>
10	3.250	1.027 <sub>7</sub>
11	3.169	0.9554 <sub>8</sub>
12	3.106	0.8966 <sub>2</sub>

Table A. Standard deviation correction multipliers.

els and “ $s_p$ ” is the variability actually observed. For the USP’s Content Uniformity test, the previous article established the special case formula presented in Equation 2a.

For “minimum process capability index,” based upon the formula for uncertainty corrected  $C_{PK}$ , developed in Part 1<sup>1</sup>, the general formulas are as shown in Equations 3 through 3-2b.

Based upon the insights provided by the authors of “Statistical Methods for Quality With Applications to Engineering and Management,”<sup>5</sup> one of the reference texts consulted,<sup>4-10</sup> the following apply to using the preceding equations in the validation of a pharmaceutical process step based upon a small number of batches:

1. A “Minimum Process Capability” approach should be used, where it is possible to do so, because it measures the expected minimum performance capability of a process while the “minimum process capability index” measures the actual minimum performance capability observed for the small set studied.
2. A Capability ( $C^*_p$  or  $C^*_{pk}$ ) or Capability Index ( $C^*_{pk}$ ) value that is not greater than 1.00 indicates that the process is not capable.
3. Values from 1.00 to 1.33 indicate that the process studied generates a product that is barely manufacturable.
4. A value of 1.34 indicates that one has a minimally capable process.
5. Values of 1.34 to 3.00 indicate that one has a good process.
6. Values that are greater than “3.00” indicate an excellent process (see Note 1).

With the preceding in mind, let us apply the preceding to two examples<sup>2,11</sup> and discuss the results obtained in each case. Then, following the discussion of the examples, the article will discuss some general equations that apply to some other USP-based process attributes.

## Correcting the Observed Process Mean and Process Variability for their Uncertainty

### Correcting the Observed Process Mean for its Uncertainty

Consulting a suitable reference statistical text<sup>9</sup> for a valid approach to determining uncertainty in a mean value when knowledge of the true variability of the population cannot be assumed, one should find that a two-sided confidence interval procedure in which the calculated correction interval is expected to bracket the true population mean 100 (1- $\alpha$ )% of the time can be used as an acceptable approach provided “ $\alpha$ ” is 0.01 or smaller (this “ $\alpha$ ” restriction is imposed because the population of most drug product batches is several orders of magnitude greater than 100 doses). Using this approach and remembering that our goal in validation is, or should be, to establish the minimum capability of the process, one should compute the  $PM_{ULE}$  using Equation 3-1.

In the typical “ $n = 3$ ” PQ validation case (Table A), this results in the  $PM_{ULE}$  correction’s being the process mean plus (5.7302 times  $s_p$ ). Considering content data from a case outlined in another white paper by the author,<sup>11</sup> where the three, content uniformity (CU) mean values were 102.35, 102.32 and 102.28% of label claim (% LC) for the 200 representative units from each of the three PQ batches tested (Table B), the “observed process mean,”  $m$ , was 102.3% LC with a mean standard deviation,  $s_{mean}$ , of 0.0375% LC. Thus, that process’  $PM_{ULE}$  is (102.3 + [5.7302 x 0.0375]) or 102.5% LC. In this case, because  $s_{mean}$  was small, the correction is only 0.2% LC even though the standard deviation multiplier is nominally “5.73.”

In another example, CU results from three validation batches were determined and reported in a recently published article.<sup>2</sup> The CU means, based upon averaging the 30 units tested from each of the three validation batches studied, were reported as 100.8, 100.7 and 103.0% LC. In this case,  $m$  and  $s_{mean}$  were 101.5% LC and 1.3% LC, respectively. Using the data set reported, the nominal  $PM_{ULE}$  is (101.5 + [5.73 x 1.3]) or 108.95% LC.

Though the difference in the mean standard deviations for the two cases, “0.037% LC” and “1.3% LC,” cannot be attributed solely to the difference in the number of samples tested, testing almost seven times as many samples contributes to the smaller standard deviation reported in the first case as shown by the individual set  $m$  and  $s_{mean}$  values - Table B.

### Correcting the Observed Process Variability for its Uncertainty

Based upon the previous article,<sup>1</sup> the nomograph alluded to previously (“Minimum Number of Representative Samples Required for a Sufficiently ‘Accurate’ Measurement of the Variability of a Population”<sup>4</sup>) or a comparable graphical figure, must be used to determine, at some level of confidence the percentage uncertainty (in terms of a percentage, P%) in the calculated variability value. Because most drug product batches consist of hundreds of thousands to tens of millions of units, it should be obvious that the 99% confidence level is the minimum confidence level to use in assessing the variability uncertainty for a given factor. For that very same size reason, the applicable minimum representative sample testing requirements of ISO 3951:1989 (or the equivalent American National Standard, ANSI/ASQC Z 1.9-1993) for the PQ validation case (population standard deviation unknown), the minimum number of representative sample units tested from each batch in PQ must be 200 for each variable factor because the population variability for the factor is not known.

Given that the FDA's general expectation is that at least three batches must be manufactured, sampled and tested in the PQ phase of validation, that minimum number of representative sample units per batch translates into a minimum of 600 units' being tested during PQ. Based upon the nomograph cited, the variability uncertainty is about 7.2% at the 99% confidence level when the process is characterized by 600 units. In contrast, if as many as only 30 units are tested from each of three batches in a PQ set, then, even if ignoring the problems of representativeness, the variability uncertainty is about 19% at the same confidence level.

### A 200 Representative Samples Case

Revisiting the data from the white paper, referenced earlier in this discussion<sup>11</sup>, the overall content variability was 1.9% LC (the 200 representative-unit test results from the individual batches used in a three-batch PQ set [batches D2, D3, and D4 in Table B] yielded content uniformity standard deviations of 1.88% LC, 1.88% LC and 1.91% LC respectively). Because: a) 600 samples were tested in all and b) the individual process mean and process variability results from each of the three batches were within experimental error the same as the corresponding values for the other two batches in the set, the batches obviously belonged to the same process population. Thus, the percentage error in the variability observed for the process, "1.9% LC," can validly be taken as about 7.2% ("599" degrees of freedom for the "600" process test results, 200 batch-representative results for each of three PQ-set batches).

Based upon the value observed for the variability and the interpolated multiplier for uncertainty, the term "1 + P/100" is equal to "1.072" and the upper limit estimate of the variability is (1.072 x 1.9) or "2.0<sub>368</sub>% of label claim." Considering the graphical uncertainty in the interpolated value of "P," the reported value can be expressed as 2.0<sub>368</sub>% of label claim. Remembering that PM<sub>ULE</sub> was found to be "102.5% LC" and that the factor being evaluated is content variability (content uniformity), then, the appropriate validation estimate for the capability index for that process, its minimum capability index, can be determined by substituting the values found appropriately into Equation (3-1) and solving for C\*<sub>PK</sub> (CU). When the appropriate substitutions are made, the result is C\*<sub>PK</sub> (CU) ≅ (115 - 102.5)% / [3 x 2.0<sub>368</sub>] = 2.0<sub>457</sub>.

When the target-based capability approach is used (see Equation 2a) with the predetermined process target of 102.3% LC, then the minimum predicted process capability computed is: C\*<sub>P</sub> (CU) ≅ (115 - 102.3)% / [3 x 2.0<sub>368</sub>] = 2.0<sub>784</sub>.

In contrast, if the standard C<sub>PK</sub> formula, Equation 4, is used, the process capability index is: C<sub>PK</sub> (CU) ≅ (115 - 102.3) / [3 x 1.9] = (12.7) / [5.7] ≅ 2.2<sub>281</sub>.

Thus, even when 200 representative units from each batch in a well-behaved process were tested in a 3-batch PQ study, the uncertainty corrections decreased the actual process capability, computed using Equation 3-1 by about 9% and the predicted process capability, computed using Equation 2a, by about 7%, even when the values for all batches were validly lumped together to raise the number of "process" results to 600 units.

However, both minimum process capability estimators, C\*<sub>PK</sub> (CU) and C\*<sub>P</sub> (CU), indicate that the process studied in the PQ studies presented can be classified as a "good" drug-product manufacturing process based upon the classification scheme established.<sup>5</sup> Moreover, the results support using the uncertainty corrected variability, 2.0% LC, as the "true" process variability.

In turn, because the variability of that drug manufacturing process is now "known," routine sample testing may validly be reduced to 42 representative units as outlined in SECTION D of ANSI/ASQC Z 1.9-1993, because the predicted percentage of the population that is outside of specification is less than 0.1% (a process capability of 2.0+ indicates that probably less than 0.000004% of the batch is outside of the release content uniformity specifications established).

### A 30-Tablet Samples Case

Likewise, revisiting the data in the Reference 2, and accepting that 30 tablets from each batch are somehow representative of each batch and that the individual lot variability values (3.43% LC, 3.99% LC, and 4.00% LC) are the "same" within experimental error, then, based upon the reported data, the overall process deviation for the 90 units tested is about 3.8% LC. The 99% confidence variability uncertainty for 89 degrees of freedom (90 units) is about 19% and, as determined previously, that process had a calculated process mean of "101.5% of the label claim" and a PM<sub>ULE</sub> (CU) of "108.95% of label claim."

Based upon the preceding, the appropriate validation estimate for the capability for the process studies in the referenced article, its minimum capability can be determined by substituting the values found appropriately into Equation 3-1 and solving for C\*<sub>PK</sub> (CU). When the appropriate substitutions are made, the result is:

$$C^*_{PK} (CU) \cong (115 - 108.95) / [3 \times 4.522] \cong (6.05) / [13.566] \cong 0.45$$

a value that all recognize as indicating that the process is "not capable."

Moreover, even presuming that process was targeted at 101.5% of label claim in a manner that permitted the valid use of Equation 2a, the C\*<sub>P</sub> computed:

$$C^*_{P} (CU) = (115 - 101.5) / [3 \times 4.522] = (13.5) / [13.566] = 0.995_{134} (\approx 1.00)$$

only establishes that the drug product process, at best, is approaching the "barely manufacturable" state according to the authors of Reference 5 who categorize capability and capability index values between 1.00 and 1.33, inclusive, as "barely manufacturable."

Finally, even using the basic C<sub>PK</sub> approach (Equation 4) that ignores the uncertainties in both the process mean and the variability that the results obviously contain, the C<sub>PK</sub> value<sup>12</sup> that should have been found is:

$$C_{PK} (CU) \cong (115 - 101.5) / [3 \times 3.8] \cong 1.18 \text{ — a value that is still in the "barely manufacturable" category.}^5$$

Thus, when 30 units from each batch in the 3-batch PQ study reported in Reference 2 were tested and the test results combined to generate a 90-result estimate of the capability of the process, applying both uncertainty corrections decreased the predicted capability by more than 60%. Based upon the data from this literature example, it should be clear to the reader that this process was not shown to be capable based upon the data that the authors presented.

Moreover, even if the significant uncertainties in the mean and variability are completely ignored (see Equation 4), the process reported in Reference 2 was not shown to be capable because:

Tablet Set	Batch "D2"			Batch "D3"			Batch "D4"		
	Weight (mg)	Content <sup>1</sup> (%LC)	Specific Content	Weight (mg)	Content <sup>1</sup> (%LC)	Specific Content	Weight (mg)	Content <sup>1</sup> (%LC)	Specific Content
Tablets 1-25 Range (Mean) [SD]	207.4 - 212.9 (209.9 <sub>84</sub> ) [1.478]	97.45 - 105.2 (102.2 <sub>05</sub> ) [1.6751 <sub>6</sub> ]	98.67 - 104.50 (102.2 <sub>100</sub> ) [1.3286 <sub>3</sub> ]	207.3 - 212.9 (210.0 <sub>16</sub> ) [1.552]	97.96 - 106.2 (102.2 <sub>996</sub> ) [1.8256 <sub>0</sub> ]	98.97 - 104.85 (102.2 <sub>876</sub> ) [1.4382 <sub>8</sub> ]	207.5 - 212.5 (210.0 <sub>00</sub> ) [1.434]	96.95 - 106.2 (102.1 <sub>308</sub> ) [2.2255 <sub>0</sub> ]	97.79 - 105.35 (102.1 <sub>276</sub> ) [1.9432 <sub>6</sub> ]
Tablets 26-50 Range (Mean) [SD]	207.3 - 213.1 (210.3 <sub>64</sub> ) [1.808]	97.44 - 106.1 (102.4 <sub>10</sub> ) [2.0867 <sub>0</sub> ]	98.71 - 104.85 (102.2 <sub>28</sub> ) [1.5866 <sub>3</sub> ]	207.3 - 212.9 (210.0 <sub>26</sub> ) [1.896]	97.56 - 106.3 (102.4 <sub>64</sub> ) [2.0195 <sub>2</sub> ]	98.74 - 106.25 (102.4 <sub>452</sub> ) [1.7090 <sub>2</sub> ]	207.5 - 212.9 (209.9 <sub>64</sub> ) [1.763]	97.31 - 105.8 (102.3 <sub>108</sub> ) [2.2299 <sub>0</sub> ]	98.03 - 104.80 (102.3 <sub>304</sub> ) [1.7599 <sub>3</sub> ]
Tablets 51-75 Range (Mean) [SD]	207.1 - 212.4 (209.8 <sub>44</sub> ) [1.598]	96.95 - 106.0 (102.2 <sub>02</sub> ) [1.7128 <sub>5</sub> ]	98.12 - 104.80 (102.2 <sub>816</sub> ) [1.6376 <sub>6</sub> ]	206.8 - 213.4 (210.1 <sub>52</sub> ) [2.068]	96.45 - 106.4 (102.1 <sub>552</sub> ) [2.3391 <sub>7</sub> ]	97.71 - 104.70 (102.0 <sub>325</sub> ) [1.7323 <sub>4</sub> ]	206.9 - 213.4 (210.0 <sub>40</sub> ) [2.040]	97.15 - 105.4 (102.2 <sub>20</sub> ) [1.8584 <sub>8</sub> ]	98.42 - 103.93 (102.1 <sub>996</sub> ) [1.3842 <sub>6</sub> ]
Tablets 76-100 Range (Mean) [SD]	206.7 - 212.9 (209.9 <sub>56</sub> ) [1.832]	96.75 - 106.4 (102.3 <sub>044</sub> ) [1.7516 <sub>4</sub> ]	101.46 - 103.03 (102.3 <sub>232</sub> ) [1.2819 <sub>8</sub> ]	206.3 - 213.3 (209.9 <sub>08</sub> ) [1.934]	97.52 - 105.4 (102.2 <sub>34</sub> ) [1.8251 <sub>1</sub> ]	101.01 - 102.97 (102.2 <sub>744</sub> ) [1.3400 <sub>3</sub> ]	207.0 - 212.8 (209.8 <sub>64</sub> ) [1.434]	97.11 - 105.6 (102.0 <sub>144</sub> ) [1.8766 <sub>0</sub> ]	98.00 - 105.25 (102.0 <sub>776</sub> ) [1.4801 <sub>4</sub> ]
Tablets 101-125 Range (Mean) [SD]	207.6 - 213.4 (210.0 <sub>88</sub> ) [1.472]	97.92 - 105.8 (102.3 <sub>296</sub> ) [1.7240 <sub>9</sub> ]	101.02 - 103.51 (102.2 <sub>948</sub> ) [1.2798 <sub>4</sub> ]	207.0 - 213.3 (210.1 <sub>60</sub> ) [1.552]	97.63 - 105.9 (102.2 <sub>704</sub> ) [1.8025 <sub>4</sub> ]	98.31 - 104.65 (102.1 <sub>884</sub> ) [1.3266 <sub>7</sub> ]	206.9 - 212.9 (210.1 <sub>40</sub> ) [1.434]	98.05 - 105.8 (102.6 <sub>180</sub> ) [1.3539 <sub>2</sub> ]	99.52 - 105.40 (102.5 <sub>468</sub> ) [0.9935 <sub>4</sub> ]
Tablets 126-150 Range (Mean) [SD]	206.9 - 213.1 (210.0 <sub>64</sub> ) [1.656]	97.25 - 106.1 (102.6 <sub>04</sub> ) [2.0794 <sub>1</sub> ]	98.45 - 105.00 (102.5 <sub>668</sub> ) [1.5599 <sub>1</sub> ]	206.6 - 213.4 (210.1 <sub>20</sub> ) [1.735]	98.25 - 105.4 (102.2 <sub>696</sub> ) [1.6841 <sub>5</sub> ]	98.14 - 103.72 (102.0 <sub>068</sub> ) [1.1725 <sub>4</sub> ]	206.5 - 212.9 (210.0 <sub>36</sub> ) [1.796]	96.92 - 105.2 (102.4 <sub>196</sub> ) [1.7497 <sub>3</sub> ]	98.32 - 104.50 (102.3 <sub>968</sub> ) [1.2144 <sub>4</sub> ]
Tablets 151-175 Range (Mean) [SD]	206.5 - 212.7 (209.9 <sub>36</sub> ) [1.944]	97.54 - 105.9 (102.3 <sub>16</sub> ) [1.9564 <sub>6</sub> ]	99.05 - 105.10 (102.3 <sub>40</sub> ) [1.2380 <sub>3</sub> ]	206.5 - 213.4 (210.2 <sub>56</sub> ) [2.173]	97.81 - 106.2 (102.7 <sub>76</sub> ) [1.9195 <sub>9</sub> ]	99.08 - 104.85 (102.6 <sub>468</sub> ) [1.3106 <sub>9</sub> ]	207.5 - 212.5 (209.9 <sub>80</sub> ) [2.383]	97.31 - 105.9 (102.3 <sub>628</sub> ) [1.9901 <sub>7</sub> ]	98.86 - 104.70 (102.3 <sub>916</sub> ) [1.3402 <sub>7</sub> ]
Tablets 176-200 Range (Mean) [SD]	206.5 - 212.9 (210.3 <sub>08</sub> ) [1.801]	97.45 - 105.8 (102.4 <sub>544</sub> ) [2.0018 <sub>0</sub> ]	98.91 - 104.65 (102.2 <sub>992</sub> ) [1.5197 <sub>9</sub> ]	206.5 - 213.5 (209.9 <sub>80</sub> ) [1.869]	97.95 - 106.1 (102.3 <sub>32</sub> ) [1.5518 <sub>6</sub> ]	99.61 - 104.36 (102.3 <sub>500</sub> ) [1.1093 <sub>6</sub> ]	206.5 - 213.5 (210.0 <sub>00</sub> ) [1.792]	97.79 - 105.0 (102.1 <sub>644</sub> ) [1.8643 <sub>3</sub> ]	99.01 - 103.96 (102.1 <sub>992</sub> ) [1.2446 <sub>8</sub> ]
GRAND Range (Mean) [≡ SD]	206.5 - 213.4 (210.0 <sub>68</sub> ) [1.70]	96.75 - 106.4 (102.3 <sub>544</sub> ) [1.88]	98.12 - 105.10 (102.3 <sub>179</sub> ) [1.44]	206.3 - 213.5 (210.0 <sub>772</sub> ) [1.85]	96.45 - 106.4 (102.3 <sub>263</sub> ) [1.88]	97.71 - 106.25 (102.2 <sub>789</sub> ) [1.40]	206.5 - 213.5 (210.0 <sub>030</sub> ) [1.79]	96.92 - 106.2 (102.2 <sub>801</sub> ) [1.91]	97.79 - 105.40 (102.2 <sub>801</sub> ) [1.45]

<sup>1</sup> Each content value is the spectrophotometric averaged equivalent of 10 readings adjusted so that a 105% of the 102% target value generates a 0.5 AU absorbance to minimize the overall spectrophotometric variability contributions to the result values measured. Because the Class A, calibrated glassware used was limited to glassware that had a volume within the ASTM 1-SD limits for their target volume, the volumetric solution preparation inaccuracy was not more than ± 0.5%, worst case.

Table B. Weight and content values summary from reference 11.

1. its overall standard-formula  $C_{PK}$  value of 1.18, is less than 1.33, the minimum value, according to the authors of that paper, for a "capable" process, and
2. two of the three batches had reported<sup>12</sup> standard-formula " $C_{PK}$ " values of less than 1.33.

Furthermore, when the appropriate corrections for the upper limits in the uncertainty for both mean and variability values reported are applied, it is clear that data reported for this process does not demonstrate that the process operated in a controlled manner much less a capable one. (See Note 2.)

Actually, for solid oral dosage form product batches larger than 150,000 units, at least 200 samples must be tested from each lot in order to satisfy the minimum sample number requirements of ISO 3951:1989 for the variability unknown

case. Moreover, to assure that the minimum capability values computed for the process do truly establish that, with a high degree of assurance, the process is valid when the uncertainty in the mean or the variability observed is significantly larger than the values computed in the 200-unit example case provided in Reference 11:

1. more than 200 representative samples should be tested from each batch
2. more batches than the usual three should be made and tested
3. both more samples and more batches need to be tested.

That having been said, let us begin to address other USP tests and establish valid equations for use in characterizing the minimum capability of a process for those factors.

### Valid Drug-Product Process Capability Assessments for other USP Tests

#### Process Capability Assessment for a Degradant Impurity - The "Impurity Increasing with Time" Case

First, let us discuss the setting of a drug-product batch release specification for a USP-controlled quantitatively measured degradation-related impurity that increases over time. For this impurity test, the batch-release lower limit is one of the following: a) the Detection Limit (DL) for the validated test method used, b) the Quantitation Limit (QL) for that test method or c) uncertainty corrected level of the impurity determined by the testing, depending upon the magnitude of the signal generated by the samples tested at release ("time zero"). The maximum lifetime level is the USP upper limit.

To establish the maximum allowable value for the release specification range, one needs to subtract the maximum degradation allowed over the required drug-product lifetime from the USP's compendial limit. Because the impurity values determined are on composited homogenized samples, the degradation correction projected over the drug product batch's lifetime should be adjusted for uncertainty to be the 99% confidence upper bound value, as discussed previously, rounded up to the least significant figure in the USP's limit value.

Provided the result of subtracting the maximum projected loss from the USP's lifetime limit is greater than the lower release limit established, the process can be presumed to be capable of producing acceptable drug product. Thus, the initial impurity level in the active and the amount of degradation caused by the process are critical issues in determining whether or not a given manufacturing process can be viable. Moreover, because impurity values cannot be less than "zero" (actually, not less than the method's Detection Limit) and are related to their active's level in the units composited and homogenized for the test, the release range also must be reduced by some amount to account for the fact that a small number of measurements is being made on a large population of measurables. In the Quantitation Limit Case, one can simply halve the range. In the case where the initial level is above the Quantitation Level and the range has already been reduced by using  $PM_{ULE}$ , the appropriate reduction is by one-third resulting in a two-thirds multiplier.

For example, if the USP maximum is "1.0%," the drug-product is known to form not more than "0.1%" of degradant each year, and a "2 year" dating period (lifetime) is required, the maximum release upper limit would be 1% minus (0.1%/

year x 2 year) or "0.8%." Thus, the maximum upper limit that could be justified in the preceding example is "0.8%." If no impurity is detected, the minimum percentage that is possible is the validated detection limit percentage of the method (" $[Detection\ Limit]_{Method}\%$ "). In the general case in such instances, the release specification range for any such impurity would be from " $(Detection\ Limit)_{Method}\ Impurity\%$  to  $([Upper\ Limit]_{USP} - [Projected\ Maximum\ Gain]_{Impurity})\%$ ." However, in this case, no exact capability can be determined as there are no impurity values from which to compute a valid "variability."

When the initial level of impurity is above the detection limit, but not more than the quantitation limit of the method, the release specification range should be reduced to "from  $(Quantitation\ Limit)_{Method, Impurity}\%$  to  $([Upper\ Limit]_{USP} - [Projected\ Maximum\ Gain]_{Impurity})\%$ ." In this case, the variability in the individual values can be determined and a capability determined provided sufficient individual result values are obtained in the validation study.

Finally, when the initial level of impurity is above the Quantitation Limit of the method, the release specification range should be reduced to " $(Corrected\ Initial\ Level)_{Impurity}\%$  to  $([Upper\ Limit]_{USP} - [Projected\ Maximum\ Gain]_{Impurity})\%$ ." The constraints on computing capability are the same as in the previous case.

Because the level of the impurity increases over time, the capability of the process should be calculated using the upper-limit  $C^*_{PK}$  approach, presented earlier, based upon Equation 3, when the release Impurity upper limit is the USP Limit range minus the maximum projected degradation over the product's lifetime minus the appropriately corrected initial level or the initial level if it is below the Quantitation Limit (QL) but above the Detection Limit (DL). Further, only when the initial impurity levels are above the QL should the process value be corrected for its uncertainty by computing the process mean upper limit estimate, " $PM_{ULE}$ ."

Using for example purposes only, a "1.0%" lifetime USP limit and a maximum degradation increase of "0.2%," a detection limit of 0.01%; a limit of quantitation of 0.1% and observed initial average impurity levels, for the three possible cases, "<0.01%," "0.05%" and 0.21% (based upon the mean results, from "n" [ $n \geq 67$ ] individual determinations on three validation batches, of 0.227, 0.197 and 0.209%) with a mean standard deviation for three batch value measurements of 0.0151% (that translates into a  $PM_{ULE}\%$  of "0.3%") and Equations 3-1, the procedures appropriate for use in each case can now be illustrated.

For the case where the initial level is below the method's validated detection limit, 0.01% in the example, one can only estimate the process capability measurement since there are no valid results from which to compute process variability. Typically, the detection limit observed is taken as the lower bound for the process. In this case, the minimum process capability index estimate is:

$$C^*_{PK}(Impurity)_{DL} \sim \frac{1}{2} (0.8 - [DL]_{Method, Imp.})\% / [3 \times (1 + "P"/100) \times (s_p)]\% \approx (0.69) / [6 \times (1 + "P"/100) \times (s_p)]$$

For the case where the initial level is above the method's validated detection limit, 0.01% in the example, but not above the method's validated quantitation limit of 0.10%, "0.05%" in the example, the formula to use is:

$$C^*_{PK}(Impurity)_{QL} = \frac{1}{2} (0.8 - [QL]_{Method, Imp.})\% / [3 \times (1 + "P"/100) \times (s_p)]\% = (0.70) / [6 \times (1 + "P"/100) \times (s_p)]$$

where, though the individual values measured are uncertain,

the variability in the results generated can validly be taken as  $s_p$  provided a sufficient number of values have been generated.

For all cases where the initial level is above the method's validated quantitation limit, 0.1% in the example, but below the initial upper limit, 0.8% in this example, the formula to use is:

$$C^*_{PK}(\text{Impurity}) = \frac{2}{3} \times (0.8 - PM_{ULE, \text{Impurity}}) \% / [3 \times (1 + "P"/100) \times (s_p)] \% = 2 \times (0.5 / [9 \times (1 + "P"/100) \times (s_p)]) = (0.5 / [4.5 \times (1 + "P"/100) \times (s_p)])$$

whether, or not, the observed mean is above the middle of the allowed range for the impurity " $(0.8 - [QL]_{\text{Method, Imp.}}) / 2$ " [(0.7)/2]% or 0.35% in this case], provided a sufficient number of values has been measured during the PQ validation set.

### Process Capability Assessment for a Non-Degrading Impurity

The approach that should be used for impurities that do not increase over time is similar to the one used for when there is an increase except that the USP's upper limit is the upper limit for the maximum permissible range. Moreover, there is obviously no need to measure a process capability index value in the case where the initial level of an impurity that is known not to increase with time is initially below the USP procedure's detection limit.

Using the same example, the formula to use in this Quantitation Limit case becomes:

$$C^*_{PK}(\text{Impurity})_{QL} = \frac{1}{2} (USPLimit - [QL]_{\text{Method, Imp.}}) \% / [3 \times (1 + "P"/100) \times (s_p)] \% = \frac{1}{2} (1.0 - [QL]_{\text{Method, Imp.}}) \% / [3 \times (1 + "P"/100) \times (s_p)] \% = (0.90) / [6 \times (1 + "P"/100) \times (s_p)]$$

and, in the measurable initial level case, the formula becomes:

$$C^*_{PK}(\text{Impurity}) = \frac{2}{3} \times (USPLimit - PM_{ULE, \text{Imp.}}) \% / [3 \times (1 + "P"/100) \times (s_p)] \% = 2 \times (0.7) / [9 \times (1 + "P"/100) \times (s_p)] = (0.7) / [4.5 \times (1 + "P"/100) \times (s_p)]$$

### Process Capability Assessment for the Average Active Content, "Assay"

Though the setting of the release specification range for Assay was discussed in the prior article,<sup>1</sup> the explicit formula was not shown. In addition, the assessment of an Assay factor for its minimum capability in a process is inappropriate unless it is impossible to measure the uniformity of content in that process. Because Assay is a process "mean" property, Assay process capability is technically of limited use in assessing process variation, the usual goal in initial PQ validation studies. Therefore, this article does not address the determination of the minimum process "Assay" capability.

### General Process Capability Concerns for Factors That Decrease Over Time

In cases where critical factors are known to decrease over time ("Dissolution" and "Drug release," in many cases) towards their USP lifetime lower limit, the release specifications must be such that the release lower limit must be not less than the projected lifetime loss, " $Loss_{\text{Lifetime}}$ " above the minimum established by the USP,  $[Minimum\ Limit]_{USP}$  such that the release limit minimum is " $([Minimum\ Limit]_{USP} + Loss_{\text{Lifetime}})_{\text{factor}}$ ."

### Minimum Process Capability Assessment for Single-Point Dissolution

For "Single-Point Dissolution," the limiting USP requirements for individual units are:

1. the mean must be not less than USP drug product monograph's defined "Q"% LC (where Q is usually between 60 and 85% LC in increments of 5% LC [60, 65, 70, 75, 80 and 85% LC]),
2. not more than 2 units in 24 units can be less than "Q - 15"% LC and
3. no unit can be less than "Q - 25"% LC.

As was the case previously, the ratio of the offsets from "Q," for the  $S_2$  and  $S_3$  ranges for individuals (15:25) also support setting release limits here based upon the statistical distribution spanning technique used for CU.

Unfortunately, the USP has begun to establish a "pooled" test, derived from the individual unit specifications, for some immediate-release drug products without seemingly thinking through the true costs and problems associated therewith. While this approach may eventually be of use in reducing the testing overhead in its current form where equal volumes from 6 or 12 units must be taken and pooled for a reading, the uncertainty introduced if done automatically and the time overhead incurred if done manually combine to negate much, if not all, of its advantages.

Moreover, the validation requirements for units dissolved are increased six fold because the same number of samples results must be taken to establish a valid capability. Therefore, as long as the "pooled" specifications are related to the individual test, validation studies should study the capability of the process to meet the individuals' test requirements and not the pooled ones. Moreover, to maximize the prediction power for the units tested and meet the minimum representative results number with the least testing, the manufacturer's release tests will need to continue to be on individual units with individual specification limits that assure that any "pooled" article, including the set containing the least dissolving units in the batch, are predicted to meet the drug product's lifetime requirement.

However, the preceding issues for even individual units are complicated by the expectations of the FDA that, regardless of the USP's lifetime limits, the average release "Dissolution" result values should be less than 100% of the content of the tablet and preferably not more than 90% of the content values at the time the Dissolution medium is to be sampled so that the Dissolution differences among a set of batches can be used as some measure of overall batch "quality." [The specification question is further complicated by other sampling and testing issues surrounding the test, including the minimum number of representative units that must be tested from each batch to assure that the results from the sample tested can validly be used to describe the distribution of values in the batch or process.]

In reviewing the issues affecting the setting of an appropriate release specification for Dissolution, most firms do, or should, realize that many Dissolution specification issues are helped by minimizing the distribution of the values for unit content for the units in a batch. Consider two examples where

the process' initial content range is projected (mean  $\pm$  6 sigma) to be:

- a) about "90% LC to 115% LC" for the Reference 11 example and
- b) about "78% LC to 125% LC" for the Reference 2 example.

Because the USP Dissolution test has no explicit upper limit and, therefore, the projected content lower limit value is the key value, that value is "90% LC" in case a) and "78% LC" in b).

Based upon the preceding, one process development goal should be such that any unit in the batch, if tested at release, has a "Dissolution" value that is greater than "Q+5"% LC. In case a), targeting the "drug release percentage" for the test sampling time specified in the USP monograph for the drug product at "90%" of the content value leads to a release set of probable values that is "81% LC to 104% LC" ("a\*"). In case b), setting the same "drug release percentage" target leads to a release set of probable values that is "70% LC to 113% LC" ("b\*").

To illustrate the complexity, let us examine the effect of the USP monograph target dissolution values, "Q," on the preceding goal and "fraction released" target. While a\* presents no problem when "Q" is 75% LC or lower, b\* is not a problem only when "Q" is 65% LC or lower. Moreover, the b\* range is also an issue because the USP's current tendency is to set a "Q" of 75, 80 or 85% LC for tablet immediate-release drug products.

Keeping the preceding discussion in mind, let us proceed to discuss the two cases for single-point dissolution:

- a) unchanging or increasing over time and
- b) decreasing over time.

#### *For Stable Actives that show Either Stable or Increasing Dissolution Over Time*

For products that exhibit either:

- a) no time-related changes or
- b) increases over time

For the factor "single-point Dissolution" in which there is no upper limit, the approach adopted need only consider the initial distribution of values found and the projected population limits in establishing the capability of the process. This is the case because increases over time will only increase the proportion of the units in the population that meet the USP compendial requirements. Furthermore, the ratio of the offsets from the USP "Q," the expected minimum average dissolution value for 24 units, for the S<sub>2</sub> and S<sub>3</sub> ranges for individuals (15:25), support setting release limits based upon the statistical distribution spanning technique used for CU (see Reference 1).

Therefore, a C\*<sub>PK</sub> approach, using Equation 3-2, should be appropriately applied to the distribution of validation result values found in that testing using a permissible specification range of "(PM<sub>LL E</sub> - [Q-15])%LC." Thus, the formula that should be used is:

$$C^*_{PK}(\text{Dissolution}_1) = (\text{PM}_{\text{LL E}} - [\text{Q}-15]) / [3 \times (1 + \text{"P"} / 100) \times s_{\text{Pobs.}}]$$

where: "Dissolution<sub>1</sub>" is a single-point USP Dissolution that

exhibits no time-related decrease and "Q" is the USP's compendial mean value for the drug product being studied, provided the initial projected process distribution of units indicates that "no" units are present having values either:

- a) less than 25% of label claim below the drug product monograph's target "Q"% LC in the projected population interval from the true process mean to that mean minus 6 sigma or
- b) above the drug product's lifetime CU upper limit in the interval from the process mean to that mean plus 6 sigma.

#### *For Actives that show Decreasing Dissolution Over Time*

Having recognized the effect of the FDA's expectation and the distribution of content values on Dissolution, let us now focus upon the projected lifetime loss (LDL). Obviously, LDL must be such that the testing of an article containing units with the least content at expiry is predicted to pass. Based upon that, the firm's goal should be to set that limit at no less than "Q-15"% LC [even though, given experimental and test uncertainty, a "Q-15" choice is not entirely risk free] because setting the minimum target at "Q-25"% LC would place batches in the region where absolute failures (any unit < Q-25) are possible and frequency failures (more than 2 in 24 < Q-15) have a significant probability of occurrence. However, the issue is complicated by the degradation of the active and the components that promote active release, if any, as well as changes in the state of other components (moisture levels, phase changes, cross linking and polymerization/depolymerization).

Fortunately, provided one is careful and allows some safety margin, one can lump these effects into a single lifetime "projected dissolution loss" offset. Let us consider the case where "Q" is 75% of label claim and revisit our two "90% release at sampling time" initial product range cases, a\* and b\*. For a\*, where the initial projected dissolution minimum is 81%, a lifetime lumped-term loss (LDL) of up to "20% LC" is safe because 81-20 (61) is still greater than "Q-15" (75-15=60). For b\*, where the initial projected minimum is 70% LC, the lifetime loss must be restricted to not more than "9"% LC for the same level of safety because 70-9 is 61. Thus, in development, the firm can set a maximum dissolution loss target of less than 20% LC for a\*, but must set a target of not more than 9% LC for said loss in b\*. This is the second area in which the distribution of content values in the population affects product development and rewards those who develop highly uniform products.

Finally, provided the initial results indicate that all initial dissolution values are significantly above the drug product's "Q-15" and the projected population minimum values are not less than "Q-15+LDL," where "LDL" is the projected lifetime dissolution loss established and verified in developmental studies, then the formula that should be used to establish the minimum process capability index is similar to the one shown in the previous case.

For products that exhibit a known maximum loss in dissolution over their projected lifetime that can be defined as a constant LDL, the process capability approach should be used. This leads to:

$$C^*_{PK}(\text{Dissolution}_2) = (\text{PM}_{\text{LL E}} - [\text{Q}-15+\text{LDL}]) / [3 \times (1 + \text{"P"} / 100) \times s_{\text{Pobs.}}]$$

where: "Dissolution<sub>2</sub>" is a single-point USP Dissolution that exhibits a time-related decrease that has been characterized as having a lumped maximum loss of LDL and the other terms are as defined previously.

### **Process Capability Assessment for Multiple-Point Dissolution and Drug Release**

As has been said previously, the treatment of these factors is more complex and complicated by the fact that medium changes (and the uncertainties they introduce), multiple sampling (and the complexities introduced [including medium replacement, no medium replacement, evaporation, and correction of the current result to what it would have been had there been no sampling]), and multiple windows. Because of the preceding realities, the generation of the appropriate release specifications and capability formulas is left to the reader.

Because the setting of appropriate multiple aliquot Dissolution and Drug Release specifications is more complicated, the approach to use in setting their release appropriate specifications has not been discussed in this article because the USP typically establishes no upper limit at the last testing interval and, where lesser-time points are evaluated, the intervals follow no fixed universal pattern. Moreover, the developer of the process needs to carefully consider the test measurement uncertainty and the interactions among the release-window limits in the development of the drug product.

### **Process Capability Assessment for Other Factors**

Before considering other factors, it is important to remember that, though many factors can be assessed as measures of the capability of a process, only those factors whose variation affects the risk of the product failure, either at its release or during its lifetime, need to be assessed. Typically, in USP monograph terms, those factors for solid dosage forms are, in order of importance, "Uniformity of Dosage Units (Content Uniformity and Weight Variation)," "Drug Release" or "Dissolution," "Disintegration," "Related substances" or "Limit of \_\_\_\_\_" or "Chromatographic Impurity," and any other factor that, because of changes over time, may cause a batch to exceed its USP or FDA-mandated limits. Ideally, developmental studies should be carried out to assess the exact factors for which capability studies could be valuable after PQ to establish the soundness of the manufacturing process being validated.

Formulas similar to those presented should be developed and applied to each USP-compendially-specified, FDA-mandated or company-required batch release specification having quantitative limits (such as, Weight Variation, Thickness Limits, Hardness Limits, Disintegration Time Limits, Friability Limits, Multiple-window Dissolution Limits, Drug Release Limits, Deliverable Volume, etc.). In general, the appropriate uncertainty-correction approach presented must be used in determining the minimum capability of the process during validation.

In cases where the process mean is centered in the predetermined specification range for the factor that is being evaluated, the  $C^*_p$  approach (requiring only a variance uncertainty correction because the mean is not a part of the calculation) should be used in validation.

In cases where a  $C^*_{PK}$  approach must be used, the firm needs to correct both the mean and the variability for uncertainty when attempting to establish the minimum capability of a process from the data obtained from the PQ set in a validation study.

### **Concluding Remarks**

Hopefully, the pharmaceutical reader will take all of the crucial issues raised in the preceding article as well as those presented here to heart and, as and where appropriate, modify their approach to determining the capability or lack thereof for drug-product manufacturing processes that are being validated such that well-defined scientifically sound, appropriate PQ study tests will be conducted on a validly defined number of representative units. In validation, it is crucial that the process capability values established be based upon at least the minimum number of representative result values set forth in ANSI/ASQC Z 1.9-1993 for the variability unknown, normal level inspection case for batches of units.

In addition, by providing content uniformity examples and establishing the equations that can validly be used for a wide variety of tests in this article, the two articles have provided the reader with the tools needed to implement the approaches established in a manner that can assure the validity of a process based upon the results obtained from the initial study of a few batches, provided sufficient representative samples are tested and valid predetermined specifications are established. Moreover, these measures can be used retrospectively to assess minimum process capability from the results obtained in previously completed validation studies.

Hopefully, the prior article and the examples and equations provided herein will assist those firms in the pharmaceutical industry who have been using less appropriate or scientifically unsound sampling plans, testing plans and/or specifications for any of their drug products to recognize the deficiencies in their existing studies and take the appropriate corrective actions so that their drug product batches can be properly shown to meet the CGMP minimums as set forth in 21 CFR 211.

### **References**

1. P. G. King, "Process Validation - Establishing the Minimum Process Capability for a Drug-Product Manufacturing Process: Part 1: The Basics," *Pharmaceutical Engineering*, 19(6), 8-31 (December 1999).
2. R Keiffer and L. Torbeck, "Validation and Process Capability," *Pharm. Tech.* 22(6), 66-76 (June 1998).
3. R A. Nash, "Understanding the Process Capability Index Concept," *J. Val. Tech.* 4(3), 202-204 (May 1998).
4. Mary G. Natrella, editor, "Experimental Statistics, Handbook 91, National Bureau of Standards," Revised Edition, Government Printing Office, 1966.
5. Irwin Miller and Marylees Miller, "Statistical Methods for Quality with Applications to Engineering and Management," Chapter 8, p. 214 - 218, Prentiss-Hall, 1995.
6. Bernard Ostle and Linda C. Malone, "Statistics in Research, Basic Concepts And Techniques for Research Workers," Fourth Edition, Chapter 17, p. 535 - 547, Iowa State University Press, 1988.
7. Harry H. Holscher, "Simplified Statistical Analysis, Handbook of Methods, Examples and Tables," *Cahners Publishing*, 1971.

8. Herbert Arkin, "Handbook of Sampling for Auditing and Accounting," Third Edition, McGraw-Hill, 1984 [Discusses the effect of statistical sampling's sample size on certainty of predicted population limits].
9. J. L. Hodges, Jr. and E. L. Lehman, "Basic Concepts of Probability and Statistics," Second Edition, especially Chapter 8, p. 254-259, Holden-Day, 1970.
10. John Mandel, "The Statistical Analysis of Experimental Data," especially Chapter 10, p. 224-241, Dover Edition, Dover Publications, 1984.
11. Paul G. King, "Pharmaceutical Inspection (Sampling and Testing) Variable Properties And Inspection for Compliance the Post-Release and The Release Dichotomy," a 42-page white paper, submitted to FDA for review and comment in December 1998.
12. Unfortunately, because of errors in their calculations, the authors paper reported a value of "1.31." Further, though the authors corrected their erroneous " $C_{PK}$ " values in a "Letter to the editor" in the October 1998 issue of Pharm. Tech., they did not correct their erroneous "process is capable" conclusion.

### Notes

1. Examining these capability measures in terms of their underlying distribution, a capability value of "1.34" implies that the specification range ( $U_{LIMIT} - L_{LIMIT}$ ) covers "8.04"  $s_P$  or, in terms of the process mean ( $m_P$ ),  $m_P \pm "4.02" s_P$ , for the centered case.
2. At the 99% confidence level, if the 30 samples tested from each batch could be proven to: a) be representative of the batch and b) be statistically sufficient for use in determin-

ing the true population mean, " $\mu$ ," and, more importantly, the true population variability, " $\sigma$ ," then, the overall uncertainty in the variability, " $s_P$ ," computed for the process based upon the 90 representative results, would have to be much less than the actual about 19% value found in statistical texts that address these issues. [Moreover, based upon: a) the statistical texts that I have read in which the issues of the need for the units tested to be representative of the batch from which they were drawn, b) the minimum number of units that must be tested when the true process variability is not known and the affect of population size on the requisite sample testing minimums address and c) the fact that the minimum number of representative sample units that are required to be tested by the applicable recognized standards governing variable factors, ISO 3951:1989 and ANSI/ASQC Z 1.9-1993, the quantitative results from the testing of 30 representative units from a batch can validly only be used to provide scientifically sound PQ estimates of the batch mean and batch variation when total number of units in the batch is not more than about 500. Even when the batch mean and variability values for the three batches are the "same," the values for the combined 90 units can only be valid process PQ "content" mean and variability estimators when the population does not exceed 10,000 units.]

### About the Author

**Dr. Paul King** is an Analytical Chemist, Systems Analyst, Quality Auditor and Consultant with in-depth experience in and knowledge of the design, validation and operation of pharmaceutical and related systems to meet regulatory and other quality criteria.

Paul G. King Consulting, 33 Hoffman Avenue, Lake Hiawatha, NJ 07034-1922. 



This article shows how to use performance-based exposure control limits for pharmaceutical active ingredients to assist in the design of new solid dosage facilities, the impact it has in existing facilities and health and safety operational changes that may preclude capital investment.

Reprinted from  
**PHARMACEUTICAL ENGINEERING**

The Official Journal of ISPE  
March/April 2000, Vol. 20 No. 2

# Containment: Reducing Operator Exposure

by Scott Kaplan

## Introduction

**T**oday, the trend in the pharmaceutical industry is toward the production of higher potency compounds. These compounds provide more saleable material from each production batch by requiring a lower quantity of active ingredient in each dose. To support this trend, designers are exploring innovations in equipment and facility designs to better contain these higher potent compounds as well as advances in instrumentation to detect smaller quantities of non-contained material. These requirements for both new production facilities and existing plants focus upon protecting operators.

## Exposure Limits

An evaluation of one of today's solid dosage pharmaceutical facilities will require attention to the Occupational Exposure Limits (OEL) of the compounds being produced. Establishing permissible OELs is critical to selecting the appropriate technology to achieve the desired containment level.

The basis of containment is to separate the operator from the material being handled. There are a number of ways to accomplish this, and the primary reason for selecting one over another is usually economic. Therefore, the designer must select a cost-effective solution to provide the required level of containment.

Most manufacturers of potent compounds establish categories based upon the exposure limits of the products. An example of a standard based upon the equipment capabilities would be:

- **Category I >100  $\mu\text{g}/\text{m}^3$**   
At this level, adhering to normal cGMPs is usually enough protection for an operator. This should include hair and shoe covers and the requirement to change into a uniform that is laundered or replaced.
- **Category II <100  $\mu\text{g}/\text{m}^3$  - >20  $\mu\text{g}/\text{m}^3$**   
This is the first category that requires the use of special equipment to create an additional separation between the operator and

the materials being handled. At the Category II level, containment can usually be accomplished using laminar flow booths.

- **Category III <20  $\mu\text{g}/\text{m}^3$  - >5  $\mu\text{g}/\text{m}^3$**   
At this level, we have reached the lower level of the capabilities of laminar flow technology and another level of control must be used to separate the operator from the material being handled. Split Butterfly Valves (SBVs) are usually used to meet these requirements.
- **Category IV <5  $\mu\text{g}/\text{m}^3$**   
Below the 5  $\mu\text{g}$  level, we have reached the guaranteed limits of SBVs and we must now look to Isolation Technology to meet this containment requirement. This includes the use of glove boxes with Rapid Transfer Ports (RTPs).

The low operator exposure levels demanded today could be achieved by Protective Personnel Equipment (PPE), containing at the source or by combining the two. Recent trends suggest that, in some countries, containment at the source is preferred or even mandatory. For example, in the United Kingdom, the Substances Hazardous to Health regulations enacted in 1988 require that "so far as reasonably practicable, the prevention or adequate control of exposure of employees to a substance hazardous to health shall be secured by measures other than the provision of personal protective equipment."

If establishing permissible exposure limits is critical to proper containment design, how then can containment quantification be achieved? Permissible exposure levels can be determined by analyzing the following considerations:

- minimum daily dose
- lethal dose
- lethal concentration
- short term exposure levels
- occupational exposure levels/exposure control limits

Radioisotopes	> 1 ng/m <sup>3</sup>
Anti-Psychotics	> 1 µg/m <sup>3</sup>
Narcotics	> 20 µg/m <sup>3</sup>

Table A. Examples of control limits.

Typically, these exposure levels are based upon airborne concentrations. Table A shows examples of control limits.

Having established the control limit, it is possible to select the appropriate technology to achieve the desired containment level. In the case of a cytotoxic compound, containment concepts must be reviewed and criteria established. The following is a review of some techniques and their cost considerations.

### Personal Protective Equipment

The common belief is that PPE is the lowest cost method of employee protection since no capital expenditure is involved in equipment purchase or modifications. Unfortunately, this does not take into account the capital investment in building modifications and the operating expenses for additional airflow requirements. In addition, protective clothing must be either cleaned or if disposables are used, they must be discarded under special conditions - usually incineration and new ones must be purchased.

The choice of PPE is based upon the mechanism of the active exposure, ingested, inhaled or through dermal absorption. This will determine the type of equipment to be used. At minimum, dust masks should be used. If specific airborne contaminants are identified such as organic vapors, it is recommended that a negative pressure cartridge respirator be used. If the active can be absorbed through the skin or has a high toxicity level, a full bunny suit with Positive Air Pressure Respirator (PAPR) must be used. It should be noted that outer garments are not necessarily impervious to the passage of particles. Woven Dacron/Polyester fibers have grid sizes of up to 50 microns, therefore it is suggested that Tyvek be used which has pore size of one-tenth the size. It also should be noted that the Exhausted Cleanroom Head Gear (ECRHG) used to avoid product contamination is not necessarily suitable for OEL consideration.

A standard ECRHG has a powered fan creating a negative pressure inside the facemask. This unit draws air from the room through the perimeter of the mask and exhausts it back into the room through a High Efficiency Particulate Air (HEPA) filter. This unit is designed to eliminate product contamination by airborne materials, and does nothing to protect the employee from airborne toxic actives.

A PAPR draws air from the surroundings through a HEPA filter into the operator's mask. The air is then exhausted through the mask perimeter into the surrounding area, protecting the operator not environment. This would be the preferred unit when handling materials which may create a health hazard.

### Facility Requirements

The ideal facility will focus upon personnel and material flow. Their flow should be unidirectional, so that contaminated personnel or containers cannot move into clean areas. Any area where an operator can be exposed to airborne contaminants should be provided with both gowning and de-gowning suites. The gowning room can be an airlock with positive pressure relative to the manufacturing area and the corridor.

The operator will enter the airlock from a corridor, put on a full overall, gloves and PAPR then enter the manufacturing space through a second door. Both doors of the airlock should be interlocked so that only one can be opened at a time. Materials brought into the room should enter through a separate airlock which is dedicated for this purpose.

Ideally, when an operation is complete and materials are to leave the manufacturing space, this should be done through an additional material airlock. If space in the area is limited, it is permissible to use one airlock for both inbound and outbound items. The operator will place the items into the airlock and inspect and clean the outside surface if it is necessary.

Once the operator has entered the manufacturing space, their outer garment is considered contaminated and must be removed prior to entering the general corridors. To do this, they must enter a de-gowning area. Since the operator must remove their outer garment, they will be exposed to any contaminants on its surface. This requires that the surface of their garment be treated in some way prior to its removal. There are three basic techniques to accomplish this and each requires that the personnel enter a room prior to the de-gowning suite. The first is to use a shower to wash the powders off the surface. This requires either waterproof garments which are hot and uncomfortable or a complete disrobing of the operator since inner garments also may be wet. The second is a misting booth to adhere the material to the surface of the gown so when the operator enters the de-gowning room the particulate will not become airborne. The third is an air shower. These units can be effective if the material to be removed is not sticky or prone to static.

After conditioning, the operator enters the de-gowning area. This room is equipped with sinks and if necessary, personnel showers. Operators will remove their respirators and clean them in the sinks, then place the cleaned units in pass through lockers to be picked up from the general corridor. Outer garments are carefully removed and placed in a bin for washing or disposal. If necessary the operator will shower. At this point, they may leave the de-gowning room into the general corridor.

PPE represents only one of the possible scenarios for reducing operator exposure.

### GAP Analysis

In order to better analyze current conditions in existing facilities the GAP analysis tool for Performance Based Operator Exposure Limits (PBOEL) was developed. The primary objective of a GAP analysis is to identify any situation that could put an operator at risk for exposure to dangerous or lethal levels of a potent active ingredient. The goal for remediation is typically to design an operating system up to a level which would eliminate the need for Personal Protective Equipment (PPE). A GAP analysis includes a description of deficiencies and the resulting recommended solutions.

There are typically three-steps required for the GAP analysis:

1. development of customized GAP tool
2. complete site survey
3. document findings with cost estimate

<b>Product:</b>				<b>Company:</b>	
<b>Active Ingredient(s):</b>					
<b>PBOEL Category:</b>		<b>PBOEL :</b>		<b>Location:</b>	
<b>Carcinogen (Y/N):</b>		<b>Carcinogen Level (.1*OEL):</b>			
<b>Clean Room (Y/N):</b>		<b>Grade</b>			
		<b>ISO Classification</b>			
		<b>Class</b>			
<b>Location</b>	<b>Criteria</b>	<b>Challenge</b>	<b>If yes:</b>	<b>If no, what is recommendation</b>	
<b>Table 2 Facility Design Concepts</b>					
	<b>General</b>	<b>1</b>	Is the facility isolated through airlocks?	Go to	<b>2</b>
		<b>2</b>	Are systems or processes that pose different levels of risk segregated?	Go to	<b>3</b>
		<b>3</b>	Are there separate airlocks for employees and material?	Go to	<b>4</b>
		<b>4</b>	Are locker rooms/toilets contiguous with the area?	Go to	<b>5</b>
		<b>5</b>	Are they isolated with airlocks?	Go to	<b>6</b>
		<b>6</b>	Are there dedicated gown down facilities for removal of protective clothing?	Go to	<b>7</b>

Table B. GAP analysis tool.

### GAP Analysis Tool

A matrix-style questionnaire in a decision-tree format is developed as a tool to evaluate a potent compound manufacturing facility - *Table B*. This tool, together with Performance Based Occupational Exposure Limit (PBOEL) Categories for each product produced or planned for production, form the basis for the analysis.

The questions in the GAP analysis are designed for a simple yes or no response. For example, a typical question for a potent compound may be, "Is there an airlock in the operation?" If the answer is no, no further investigation is involved. If the answer is yes, the next question may be, "Does the airlock have positive pressure as it relates to the operation and the corridor?"

Each product is tracked through the process and packaging trains and evaluated against the criteria outlined. A sample question for a less potent compound may be, "Is the transfer of bulk materials performed under a closed system?" If the answer is no, then no further investigation is involved because remediation is required. If the answer is yes, then the next question may be "Is the existing system adequate to maintain exposure levels below the OEL?" Assessments should be scheduled in advance to provide the facility with the opportunity to gather the appropriate data.

### Gap Evaluation and Remediation

The OEL impact can range from equipment changes, use of glove box technology, need for air locks, additional gowning, and degowning, changes to HVAC systems, separation of dust collection and house vacuum systems, methods of cleaning, maintainability of equipment and safety of employees and the environment.

Items covered in performing assessments can include:

- Product (material) characteristics
- Product charging to equipment
- Product load out/containerization
- Product Sampling
- Container Selection
- Control Systems
- Safety/Shut Down Isolation
- Dust Control
- Ergonomics
- Equipment Clean-Up
- Clean-In-Place (CIP)
- Validation

Following completion of the assessments, the data is analyzed, reviewed and collated into a written report. The report would include an analysis of shortcomings and deviations, remedial options and a strategy for achieving compliance with the PBOEL and the Cleanroom Guidelines.

The strategy is to distinguish process containment problems from facility issues and prioritize them. Priority criteria is based upon the degree of potential operator exposure and weighted for the higher category compounds. For example, a lesser exposure to Category 3 product will carry a higher priority than a higher exposure to Category 2 products.

### Conclusion

Through successful research and development efforts, the pharmaceutical industry is producing new and more potent compounds. Process equipment and instrumentation are evolving to allow these compounds to be handled safely. The design

and renovation of the facilities must evolve as well to allow for the efficient production of these materials while safeguarding the equipment operators.

### About the Author

**Scott Kaplan** is a Manager with the Pharmaceutical/Biotechnology Global Client Development group of Lockwood Greene. Kaplan has 20 years of varied experience in the pharmaceutical and specialty chemical industries and holds a Bachelor's degree in engineering from Rutgers University.

Lockwood Greene, P.O. Box 491, Spartanburg, SC 29304. 

Site managers for pharmaceutical companies with mature and complex sites have a new approach to mediate between ever changing business plans and the capital intensive nature of site upgrades. Known as trigger point master planning, this new approach has helped site managers create quick, yet comprehensive, responses to “what-if” business scenarios presented at the executive level.

## Trigger Point Master Planning: A New Summary of Approach

by Jonathan Friedan and Travis Peyton

### Site Master Planning: Historical Perspective

The usual methodology of site utilities master planning is to forecast a building expansion program (i.e., develop an architectural master plan) and then develop a corresponding site utilities infrastructure master plan. Figure 1 provides the traditional infrastructure of a master planning process.

Typically, site or central engineering departments receive direction from senior planning management in terms of possible future buildings. Given the constant changing nature of future building plans most engineering departments loosely plan their future utility upgrades. Critical site infrastructure upgrades are then implemented as capital is appropriated for new buildings or as independent projects.

Site utilities which are typically the most capital intensive include:

- Chilled Water
- Steam and Condensate
- Electric Power

To a lesser extent, the following utilities also have significant capital impact:

- Domestic/Well Water

- Wastewater
- Storm Water
- Fire Protection
- Tele/Data
- Natural Gas
- Compressed Air

One problem with this traditional approach to site infrastructure master planning is that the infrastructure impact for a new building is not firmly known until utility impacts are assessed. Since it is impractical to perform individual infrastructure master plans every time a new building is suggested, the true cost of new building programs is often missed until construction starts.

### Trigger Point Master Planning: A New Approach

An alternate approach to site utilities master planning is to forecast the magnitude of a building expansion program that can be supported by the site utility infrastructure. Known as a trigger point analysis methodology to master planning, this approach relies upon identifying unused available capacity in all existing and planned (i.e., funded) site utilities. To complete

Figure 1. Traditional infrastructure master planning process.



Figure 2. Trigger point master planning process.



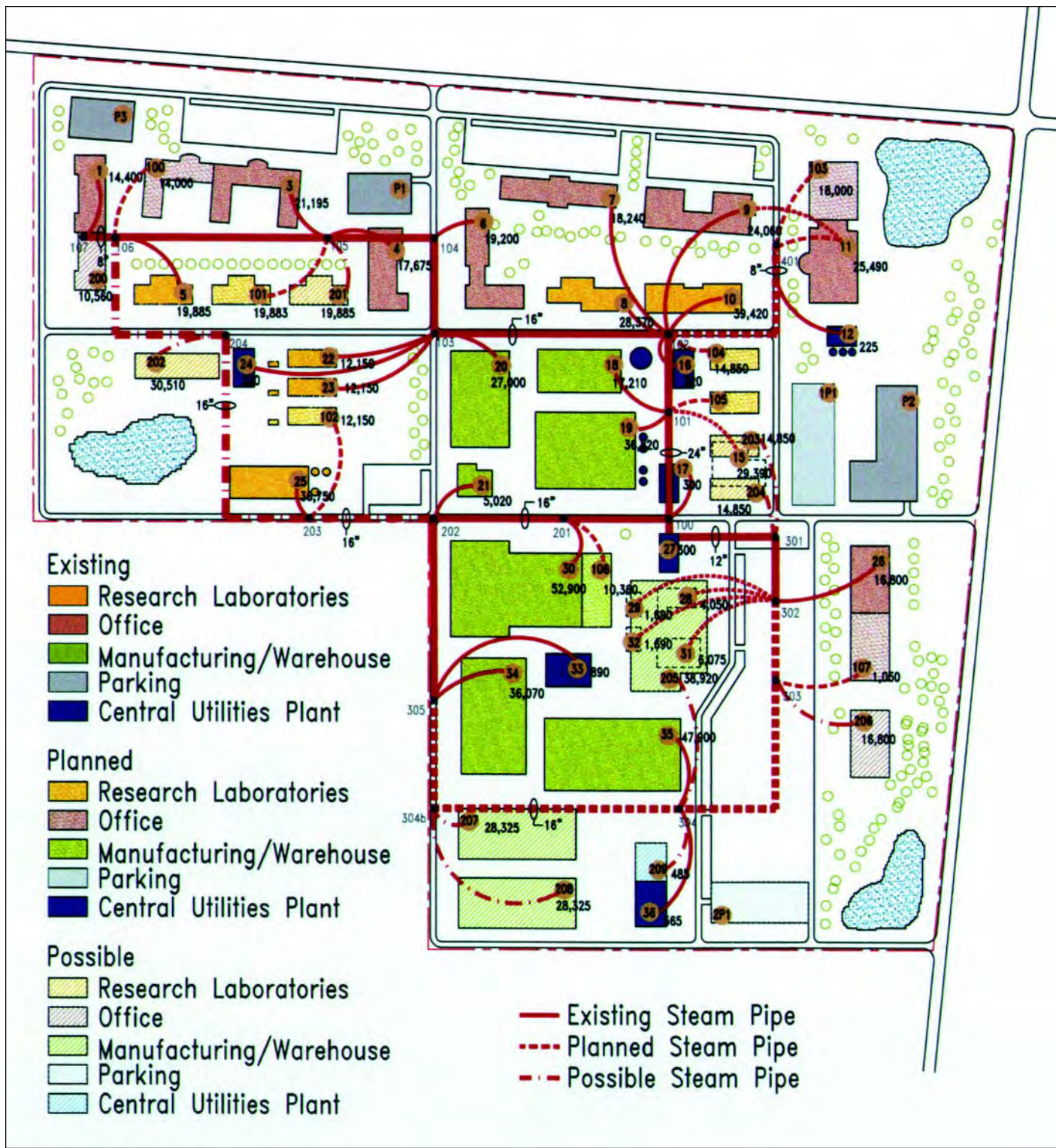

Figure 3. Example of steam distribution planning tool showing major loads and distribution only.

the trigger point analysis, an ultimate build-out plan is also identified. As new buildings come on-line according to changing business plans; they trigger elements of the ultimate infrastructure build-out plan. Figure 2 highlights the trigger point master planning process.

The motivation to use the trigger-point methodology is that predictions of building programs over a long-term basis are unreliable because expansion activities are amended as a

function of business plan changes. As one site engineer commented, "I want a site master plan that supports sound engineering judgement; however, I don't want to identify for management, infrastructure upgrades that will never happen."

Because site utilities upgrades require significant lead time and those upgrades must be in place before new buildings come on-line, the advantage of identifying trigger points is that they



**A key element of a trigger point analysis is to provide, on a spreadsheet basis for each utility, the existing peak demand and the planned demand; along with the existing firm capacity and planned capacity.**



identify what upgrades are on the critical path to meeting construction schedules and in turn production schedules.

### Trigger Point Master Planning: Objectives

Three objectives are met by creating a document set which brings together, in one place, all existing and planned (i.e., funded) site utilities. Current building loads are shown alongside available capacity of the infrastructure systems. The key to the document set is to provide the appropriate level of graphic detail such that executive level decisions can be evaluated without including an overwhelming amount of non-essential information.

- The primary objective of the trigger-point analysis methodology of utilities master planning is to provide a tool for executive management which enables them to understand the true capital costs and total schedule impact of any building expansion program.
- A secondary objective, identified by site operations staff, is the benefit of providing a clear method of relaying required infrastructure projects to capital planners far in advance of buildings coming on-line.
- A tertiary objective is that outside consultants benefit from the ultimate build-out master plan since it provides a verifiable and owner supported document identifying which design decisions are critical to site utilities.

Figure 3 illustrates an example of a steam distribution planning tool showing major loads and distribution only.

### Trigger Point Master Planning: Technique

To date, the technique of trigger point master planning has only been applied to pharmaceutical sites with a minimum of 1.0 million gross square feet (~93,000 gross square meters) of mixed use. This particular process, described herein, was developed somewhat surreptitiously from data gathering, brainstorming sessions and presentation reviews performed for a

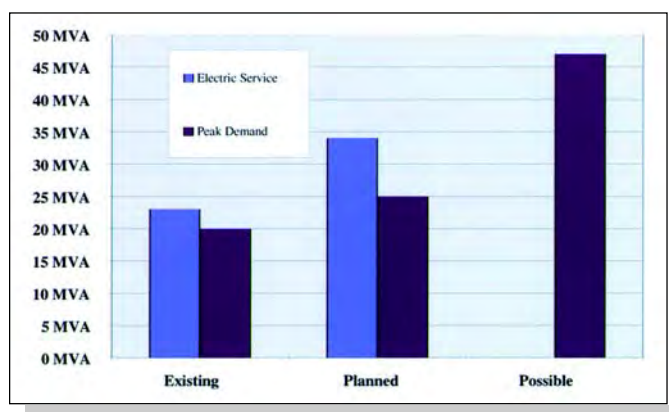

Figure 4. Current and future expected loads versus capacities.

large site with more than 5.0 million gross square feet (~465,000 gross square meters) of research, office, production and warehousing.

A key element of a trigger point analysis is to provide, on a spreadsheet basis for each utility, the existing peak demand and the planned demand; along with the existing firm capacity and planned capacity. The difference between the capacity and the demand is the amount of that utility that is available to support additional building growth. This amount of supportable building growth without triggering major infrastructure upgrades can then be relayed to executive management as an element in their business planning process. Figure 4 illustrates current and future expected loads versus capacities.

Although building growth is usually the issue being studied, the suitability of the site utility system to support existing building densification also should be assessed. Densification is the process of increasing the utility load in an existing building.

Example: Conversion of a warehouse into an R&D facility would “densify” the utility requirements for that building, even though the building did not physically “grow.”

### Trigger Point Master Plan: Site Planning

On a parallel track to the engineering determination of available capacity in existing site infrastructure is a site planning determination of the maximum possible site building density. This site planning process is not the same as a true architectural site master plan as it does not generate buildings directly from a specific business plan. The purpose of the site planning process is merely to determine the maximum possible site building density. Figure 5 provides an example of an ultimate site build-out plan.

Although the ultimate site build-out plan is not controlled by a specific business plan it should be noted that executive level buy-in of the identified maximum building density is crucial to the success of the trigger point master plan. This maximum building density determination is used to identify the maximum possible future demand that the site infrastructure would ever have to support.

The parallel process of site planning and utility infrastructure analysis in the early stages of the trigger point master plan can be seen in Figure 6. Once the infrastructure capacity model has been developed and the ultimate site build-out plan has been identified, the two products can come together to form the trigger point master plan.

Generally, the key parameter associated with the site build-out analysis is population count. In fact, individual building population capacity also can be viewed as an infrastructure similar to engineering systems. The trigger plan can then show existing population in buildings along with the identified population capacity of the buildings.

Key components that constrain the maximum building density include the following:

- Allowable Impervious Surface Site Coverage
- Allowable Floor Area Ratio



Figure 5. Example of an ultimate site build-out plan.

- Parking Space Availability
- Overall Site Circulation and Traffic Impact
- Setbacks, Height Limitations and Restrictive Covenants

Figure 7 shows details of the site planning analysis process.

### Trigger Point Master Plan: Utilities Infrastructure

A more detailed perspective of the engineering process to develop a trigger point master plan reveals the following sub-tasks:

- Overall Existing System Understanding: Sources, Loads, Distribution
- Determination of the Available Utility Capacity



- Determination of Utility Needs as a Function of Building Type
- Determination of Ultimate Utility Capacity Required

Throughout this process, it is important to note that a theme of appropriate information detail must be stressed. Examination of the steam distribution diagram in Figure 3 shows the balance between conceptual versus detailed information, which is key to being useful at the executive site management level. A site utilities director for a large site once commented, “These drawings are my ammunition when I go to the capital planning committee to use in defense of the capital outlays I request.”

### Overall Existing System Understanding: Sources, Loads, Distribution

The first task of trigger point master planning is to understand the utility generation and distribution system. For example, for a chilled water system, it is necessary to understand factors such as:

- Chilled Water Plant Capacity in Tons, Age, Arrangement and Redundancy Philosophy
- Chiller Technology (Steam Turbine, Steam Absorption, Electric Refrigeration)
- Chilled Water Distribution Strategy (Primary Only, Primary/Secondary)
- Chilled Water Distribution Pipe Sizing
- Chilled Water Demands at Each Building

Chilled water plant capacity and distribution sizing are required due to elements that could limit the ability of the chilled water system to support building growth. Chilled water distribution strategy is important to understand because primary-only distribution systems can inhibit growth by reducing the available chilled water flow to the system, which limits supply/return temperature differential.

Chiller plant technology is meaningful to the analysis because some technologies may limit future options. For example, absorption chillers are more limited in how low a supply temperature they can produce. Further, the chiller plant technology is interrelated with other parts of the evaluation. Expansion of the chiller plant using electric chillers would require assessment of the ability of the power system to support that requirement. Figure 8 illustrates details of the engineering analysis process.

The demand for each utility and for each existing building is required by the trigger point analysis model. The preferred method for capturing this data is by primary means.

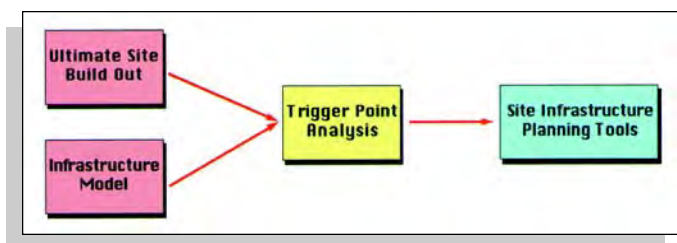

Figure 6. Overview of trigger point master planning technique.

Example: One utility manager used data trends from an energy management DDC system employing calibrated flow-meters for chilled water.

Since chilled water usage may be neither metered for every building nor the accuracy or calibration of the meters be ascertained, a combination of secondary data collection methods may be required. Historical data from similar facilities or even empirical data can be used although the accuracy of those forecasts is questionable, especially for unique buildings that cannot be easily characterized.

Example: Another less fortunate utility manager took years of patiently gathered flow and temperature data employing strap-on ultrasonic flow-meters and discussions with building and chiller plant operators to assemble an accurate picture of usage and distribution for a 70,000 ton (840 MMBTU) system. The data gathered was significantly different from the sum of the individual buildings design peak loads.

### Determination of the Available Utility Capacity

The analysis has thus far calculated the actual existing peak demand and the current capacity for each utility. The difference between those two quantities is the amount of each utility that is available to support future building growth.

Example: In a chilled water main, the existing demand is 400 tons (4.8 MMBTU) and the current capacity (up to the velocity/pressure drop constraints) is 700 tons (8.4 MMBTU) with the difference, 300 tons, (3.6 MMBTU) available to supply future buildings in that area.

### Determination of Utilities as a Function of Building Type

An analysis model can be constructed that predicts the amount of each utility as a function of building type. For example, if the site can support manufacturing, office or research programs, then the requirement for each utility could be developed for each building use. Historical data from other, similar buildings (i.e., either on that particular site or on other sites) for each service would be used in the model.

The available utility can then be “converted” to equivalent building area. Here is where the trigger points are identified.

Example: If the historical data has suggested that office, R&D and manufacturing facilities require, 325, 200 and 125 square feet per ton (2,500, 1,550 and 970 square meters per MMBTU) respectively, then the 700 ton (8.4 MMBTU) extra capacity can support any of the following:

- $(325 \text{ sf/ton})(700 \text{ tons})=227,500 \text{ sf}$  of office space  
 $(2,500 \text{ m}^2/\text{MMBTU})(8.4 \text{ MMBTU})=21,000 \text{ m}^2$  of office space
- $(200 \text{ sf/ton})(700 \text{ tons})=140,000 \text{ sf}$  of R&D space  
 $(1,550 \text{ m}^2/\text{MMBTU})(8.4 \text{ MMBTU})=13,000 \text{ m}^2$  of R&D space
- $(125 \text{ sf/ton})(700 \text{ tons})=87,500 \text{ sf}$  of manufacturing space  
 $(970 \text{ m}^2/\text{MMBTU})(8.4 \text{ MMBTU})=8,150 \text{ m}^2$  of manufacturing space

### Determination of Ultimate Utility Capacity Required

At this stage, the architectural maximum site build-out scheme is input into the developed infrastructure model.

Oftentimes at this stage, funded infrastructure projects begin to reveal short-term capital spending horizons and

overall capital spending inefficiencies. One executive who participated in the process stated, "Although generally too late to change the course of an existing funded infrastructure upgrade project, review of maximum build-out impact does tend to modify future infrastructure upgrade plans such as to optimize capital outlays."

**Trigger Point Master Plan:  
Obstacles to Overcome**

As with any large site the number of people involved in all aspects of site system planning can be staggering. The resulting obstacle is one of obtaining appropriate data inputs, system capacities and future system plans without seeding a storm of speculation and unnecessary detailed planning for a possible maximum build-out that may not occur for 40 years if ever.

The solution to the people involvement problem is to identify five key people:

1. Assigned Executive - identifies "reasonable" maximum future, understands business plan
2. Utilities Director - has overall capital funding request responsibility for all utilities
3. Site Master Planner - has "stakeholder" interest in the utility trigger point results
4. Senior Engineer - serves as final arbitrator in system capacity criteria
5. Project Manager - serves as "champion" for the entire process, sets timetable



Figure 7. Details of site planning analysis process.

Limiting review of the trigger point master plan process to these key players allows for timely decision making without losing key input.

Another critical obstacle that invariably surfaces is one of data gathering. By virtue of having older buildings and utility systems, oftentimes the process of gathering usage data is not in place or has been abandoned.

The solution to the data gathering obstacle is early identification of available data and continuous representation of data in graphic form along with multiple reviews with system operators, senior engineers, old design documents, past studies, etc. Data should be analyzed on a square foot basis and then examined for anomalies.

### Trigger Point Master Plan: Deliverables

The results of a trigger point master planning process can be seen beyond the specific deliverables at the end. The process of gathering data and distilling it into usable information at the senior management planning level becomes the most visible

result as individual utility managers begin to take on a more active role. The tools that are developed become an integral part of the capital funding decision making and key stakeholders gain a greater sense of participation. Figure 9 illustrates an overview of trigger point process and results.

### Existing, Planned and Possible

For most large pharmaceutical sites beyond actual funded projects, the future of any building and any infrastructure upgrade is very fluid. This fluidity can translate into a form of paralysis on the infrastructure planning side where only short-term needs are developed beyond conceptual engineering.

Because of this long term uncertainty, the trigger point process documents existing conditions as the base set of drawings and then only documents actual funded projects as the “planned” set of drawings. Although numerous additional infrastructure upgrades and new building plans could potentially be imminent, it is generally recognized that each utility

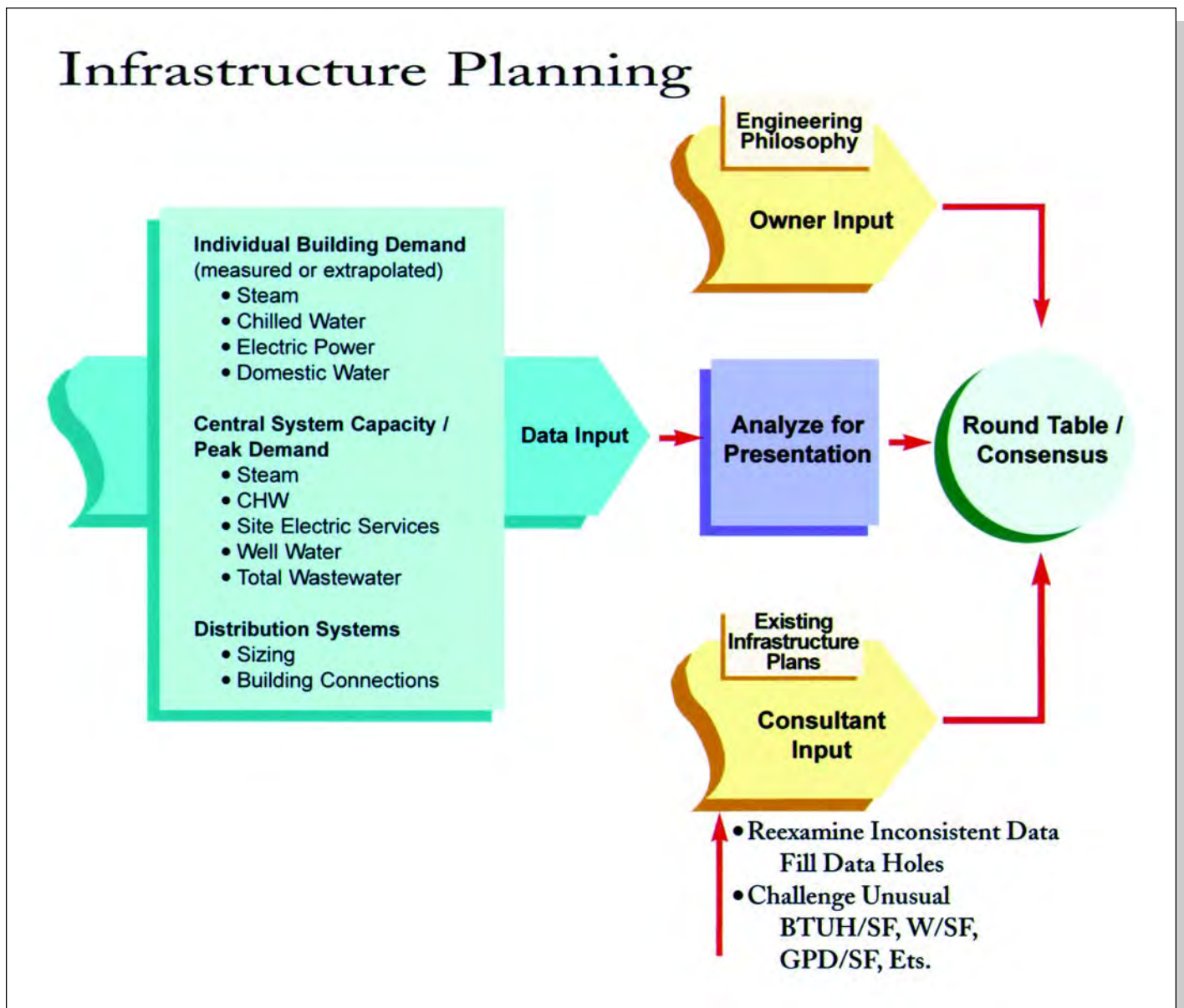

Figure 8. Details of engineering analysis process.

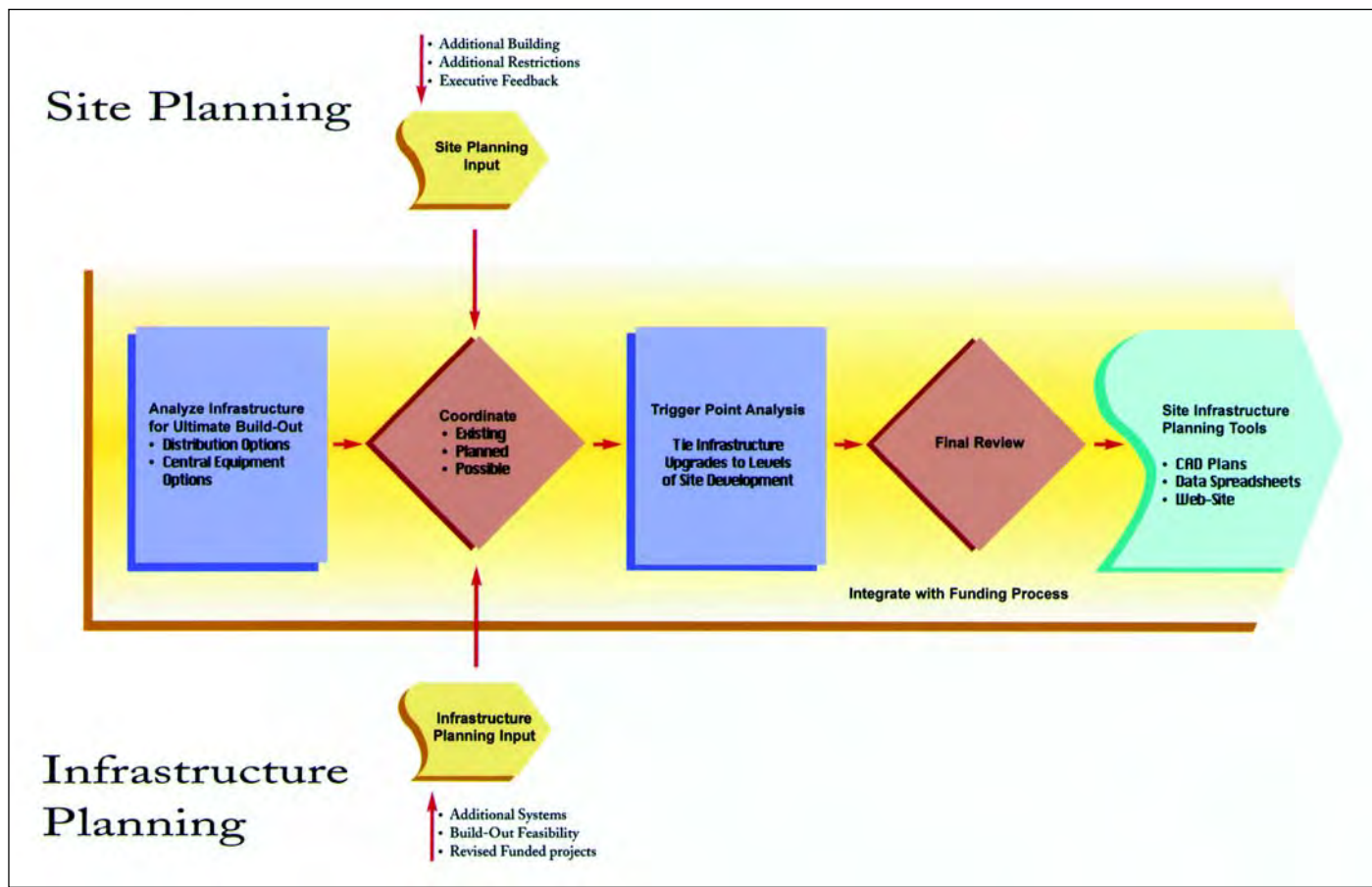

Figure 9. Overview of trigger point process and results.

system owner has multiple upgrade pathways or options in mind as they move forward in site development.

The concept of identifying a specific list of master planned infrastructure upgrades does not become an element of the trigger point master plan. It is quickly revealed that no one is willing to agree that short-term funding will pay for long term possibilities.

However, the conflict of wishing to understand the ultimate implications of incremental infrastructure growth generally leads to the development of an ultimate site build-out plan (i.e., possible plan).

This ultimate site build-out plan then becomes a crucial component to the drawing set where each utility develops their infrastructure upgrades to meet funded buildings while using the ultimate build-out as a guide to help select between the multiple short-term options available.

#### Data Spreadsheets

Another benefit that is found from the trigger point analysis process is the final realization that data gathering is never complete and data anomalies will continuously pop up. As such, the incorporation of the spreadsheets identifying each building's load and central plant capacity along with sizing criteria into the document set enables the data gathering and refinement process to continue on a long term basis.

#### Web Site

Finally, although not yet implemented on any trigger point master planning projects, the concept of providing all the

drawings and data on a secure web site is proposed to the pharmaceutical site management community as a solution to the problem of continuously updating numerous stakeholders for each infrastructure system.

#### Trigger Point Master Plan: Conclusions

Ownership of the deliverables becomes a key issue once senior management incorporates the results of the trigger point analysis into the capital planning process. For some sites, it turns out that determining ownership becomes problematic due to the decentralized nature of some organizational hierarchies. In the end, it generally falls to the party responsible for submitting capital funding requests to the senior management committee. Once ownership is established, the frequency of revisiting the trigger points is then largely driven by the funding cycle. However, experience has indicated that it takes at least a few updates after the initial trigger point analysis to get the process streamlined, data anomalies straightened out and data gaps plugged.

Another conclusion derived from performing the process was the need for senior management to see some form of validation that the process generated real, demonstrable and beneficial results. On one site, the proof was in the form of a negative result where the analysis was not performed and a new building triggered an unplanned site steam upgrade project. On that same site, where the process was employed, the trigger point masterplan was able to inform senior management of the capital impact of several alternate build-out

strategies during a planning summit without requiring a one month feedback loop from central engineering. Lastly, one site saw the benefit of the process from the inclusion of several systems that had not been previously incorporated into their capital forecasting process resulting in the avoidance of an expensive capital surprise.

### **About the Authors**

**Travis Peyton, PE**, is a Senior Associate and Manager of Energy Services at Ballinger. He holds a BSAE, BSCE, MSCE and MS in engineering management from Drexel University. In the pharmaceutical sector, Peyton has published articles on cGMP facilities, systems to support gene therapy research and

tuberculosis control in healthcare facilities.

**Jonathan Friedan, PE**, is Principal and Director of Engineering at Ballinger. He holds an MSME and BAE from Columbia University. He authored the engineering sections of the National Science Foundation's Planning Academic Research Facilities: A Guidebook. He has led the engineering design team on major bio-science research projects in both the university and pharmaceutical environments.

Ballinger, 2005 Market St., 15th Floor, Philadelphia, PA 19103. 

This article examines the physiochemical interaction between elastomers used in sealing and flexing applications and the process stream it is in contact with. A testing protocol is outlined, then used to evaluate the elastomers used in the pharmaceutical industry.

*Editor's Note:*  
This article is being presented at INTERPHEX 2000.

# The Impact of Elastomer Performance on Pharmaceutical Manufacturing Processes

by Timothy C. Duzick

During the past decade, pharmaceutical manufacturers have focused a great deal of energy and resources into the proper specification of stainless steel tubing, vessels and related equipment for use in pharmaceutical and biopharmaceutical processes. Heat numbers, surface finishes and Material Test Results (MTRs) are some of the standards defined by the American Society of Mechanical Engineers (ASME) for use in the biopharmaceutical industry. This body of work was formally published as the ASME BPE-1997.<sup>1</sup>

While ASME BPE-1997 mentions the role of seals in bioprocessing equipment, actual specifications are vague and only address their mechanical requirements. Unlike metals, elastomers and other sealing materials are fabricated using a wide variety of polymers, fillers, crosslinking agents and other ingredients. In general, these ingredients are necessary to impart specific positive sealing characteristics. However, in the pharmaceutical industry, special care must be taken in selecting seals. Polymeric sealing materials and their ingredients are more likely than metals to interact with process fluids, creating a potential for contamination and product loss.<sup>2</sup>

How can pharmaceutical engineers obtain an elastomer that exhibits the same cleanliness and inertness of polytetrafluoroethylene (PTFE) yet provides the sealing dynamics required? The number of ingredients required to make an elastomer may seem prohibitive to cleanliness, but adequate and well documented testing techniques can help determine the level of cleanliness of a particular elastomer.

Since PTFE is considered by most in the pharmaceutical industry to be an "inert and clean" material, pharmaceutical engineers have

no choice but to use a plastic, i.e. PTFE, in sealing and flexing applications such as sanitary seals, diaphragms, o-rings in mechanical seals and seats for stem and rotary valves. If an elastomer can be found that exhibits the same physiochemical characteristics as PTFE, then that elastomer can be used in applications where PTFE is currently specified. An elastomer has the further benefit of being a homogeneous compound, whereas PTFE is a sintered, and thus a porous plastic.<sup>3,4</sup>

This article outlines a testing protocol that can be used by pharmaceutical engineers to determine the optimal sealing material for use in a particular process stream. Although the focus is on seals and sealing materials, it also can be used to determine the proper material for diaphragms, stem valves and other related equipment that requires a resilient sealing material. This testing protocol will then be used to characterize the five major FDA compliant elastomers used in the pharmaceutical and biopharmaceutical industries: ethylene-propylene-diene rubber (EPDM), fluoroelastomers (FKM), platinum-cured silicon (pt-Si), and finally the Kalrez<sup>®</sup> perfluoroelastomer parts using compounds KLR-6221 and KLR-6230, which are perfluoroelastomers. These results are compared to PTFE, widely considered to be an "inert and clean" material of construction.

## Introduction to Polymers and Elastomers

Before any interaction between an elastomer or plastic and the process fluid can be quantified, it is important to understand what an elastomer is and what can be included in its formulation.

A polymer is defined as a macromolecule consisting of five or more repeating units called monomers. Examples include polyethylene, polystyrene and polytetrafluoroethylene (PTFE) - *Figure 1*.

Most polymers, including PTFE, can be fabricated without fillers or plasticizers, but many require a processing aid to facilitate manufac-

### Chemical Structure of PTFE

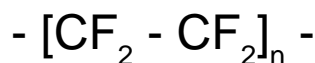

Figure 1.

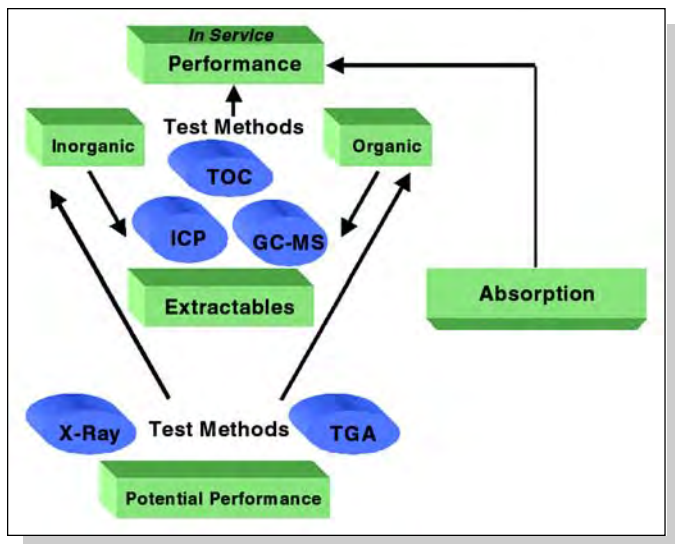

Figure 2. Physiochemical test protocol.

turing. Because it lacks fillers, PTFE is widely considered to be a “clean” material that does not contribute to process contamination. PTFE is a good choice where resilient mechanical properties are not required. However, in many cases, engineers choose PTFE seals and diaphragms because they are not convinced that there are “clean” elastomers.

Polymer systems consist of many chain units, locked together only by physical entanglement between the chains. Mechanical strength is either derived from physical entanglement or regions of crystallinity between two or more polymer chains.

Elastomers typically are long chain co-polymers or ter-polymers (two or three different monomers in one chain) that contain adequate crosslinks among individual chains. These crosslinks give the elastomer its unique elastic properties that are ideally suited for sealing and flexing applications. Elastomer systems are much more complex than plastic systems. A typical elastomer system has four major components: a polymer chain, cure sites, a crosslinking system, fillers and perhaps plasticizers. The functions of each of these ingredients are summarized below.

Polymer chains range from ethylene-propylene (EP) copolymers to PTFE - hexafluoropropene (HFP)-vinylidene fluoride (VF<sub>2</sub>) ter-polymers found in specialty fluoroelastomers. In general, the polymer chain significantly defines the elastomer’s chemical and thermal stability. Fluorinated elastomers are more stable than hydrocarbon or silicon elastomers because C-F bonds are approximately 30% stronger than C-H bonds.

Cure-site monomers and accelerators, molecules that help to bond one chain to another and speed-up curing and crosslinking agents, are usually the most proprietary aspect of an elastomer formulation. Historical examples of cure-site monomers for ethylene-propylene-diene (EPDM) elastomers are 1,4 hexadiene and dicyclopentadiene.<sup>5</sup> Crosslinking can be accomplished by the chemical reaction with sulfur or peroxides. Fluoroelastomers may be cured by diamines, peroxides or bisphenols. Peroxide-cured fluoroelastomers do not conform to FDA-21 CFR guidelines, and thus are not considered in this article. Cure-site monomers and crosslinking agents used in perfluoroelastomer fabrication are typically proprietary formulations.

Fillers are added to increase the strength of an elastomer system. Typical fillers include carbon black, barium sulfate, titanium dioxide, silica or clays. Fillers also can be added to adjust compression set resistance, enhance chemical resistance or improve heat stability.

Physical plasticizers include low to medium molecular weight hydrocarbon oils, fatty acids or esters. They are added to elastomers to soften the compound by reducing entanglement and decreasing internal friction. An additional benefit is that plasticizers may improve low temperature flexibility and improve processability.<sup>6</sup> They are usually added in levels up to 10 parts per one hundred parts of the elastomer.

### Physiochemical Interaction

The physiochemical interaction between an elastomer system and a process stream is probably the most important criterion in selecting the material that should be specified for sealing or diaphragm applications. This interaction comprises two distinct mass transfer operations: equilibrium physical absorption by an elastomer, and steady state extraction by a process stream. Absorption occurs when the components in a process stream (solvent) are thermodynamically compatible (soluble) with the partial or overall composition of an elastomer (solvate). The degree of solubility is directly related to the chemical structure of the solvate and the solvent. In simpler terms, like diffuses into like. For example, hexane, a non-polar hydrocarbon, is very compatible with EPDMs since the monomers that make-up EPDM are also non-polar hydrocarbons. On the other hand, EPDMs are incompatible with water since water is a very polar molecule. Thus, EPDMs are frequently specified for use in aqueous process streams.

Extraction involves the removal of a component of a polymeric compound by selective solubility if the component of the elastomer/polymer is compatible with the process stream. Inorganic compounds that contain metals such as sodium and calcium are very soluble as salts or hydroxides in water, and these metals are usually found in most industrial water supplies. However, in water-for-injection systems, these metals are absent. So, if there is any sodium or calcium in the polymer/elastomer compound, it may be extracted from the compound into the process stream. Organic materials such as plasticizers also are extracted if the process stream and the plasticizer are compatible.

Given the importance of the physiochemical interaction between an elastomer system and a process stream, it is important to quantify the interaction. It is equally important to determine which test methods and representative solvents should be used to aid in the analysis.

### Physiochemical Test Methodology

As stated earlier, the two methods of mass transfer are: absorption from a process stream and extraction by a process stream. Given these two methods a testing scheme can be constructed that covers both phenomena. The first method, absorption, is easily measured. The results can predict what will happen “in-service” if the test composition and temperature closely match the in-service conditions. Extraction is much more difficult to quantify and requires a series of different tests in order to get an accurate picture. Once absorption and extraction are both characterized, in-service performance can be estimated. The entire protocol is outlined in Figure 2.

## Absorption Method

Measuring absorption is not only straightforward, it also is accomplished by a well-documented test procedure, ASTM 471 D. The test is a gravimetric means of determining the volume swell of an elastomer after immersion in a test fluid for a specified period of time at a set temperature. Once the time period has passed, usually 70 hours, the elastomer sample is weighted and compared to its initial weight. The weight difference is used to calculate the volume swell. If there is a weight loss, it indicates that something has been extracted. This provides excellent information that can be used to select solvents for use in the gas chromatography extraction test.

Unless one has the goal of only looking at a single specific solvent, the question arises as to which solvents to select for the study. Given the large number of solvents used in the pharmaceutical industry, a representative group of solvents should be chosen to make the study manageable. This requires the use of solvent modeling in order to select representative candidates. The use of a model solvent is not a new concept. Filter manufacturers have used specific solvent groups to characterize the non-volatile residue after exposure to a filter membrane.<sup>7</sup> Model solvent methods also have been used by coating chemists to aid in the formulation or reformulation of paint systems.<sup>8</sup>

The most well known solvent model is the Hansen Solubility Parameter Theory. This theory predicts that dissolution of a solvate will occur in a solvent or a solvent blend of similar cohesive energy density values. This method of solubility characterization works well with substances that do not have significant polarity or hydrogen-bonding tendencies. The total solubility parameter can be broken down into three classes: dispersion (non-polar), polar and hydrogen bonding. They are represented by the symbols  $\delta_d$ ,  $\delta_p$ , and  $\delta_h$ . An example mentioned earlier is hexane, which is non-polar in nature ( $\delta_d = 15.3$ ,  $\delta_p = 0$ ,  $\delta_h = 0$ ) and does not associate with strong polar solvents such as water. Acetone, on the other hand, has a strong polar component ( $\delta_d = 15.5$ ,  $\delta_p = 10.4$ ,  $\delta_h = 7$ ) given the presence of the carbonyl (C=O) group. Selecting solvents with varying non-polar, polar and hydrogen-bonding parameters can yield a solvent list that theoretically can represent a very large number of solvents. The solvents chosen for this study, along with their Hansen solubility parameters, are listed in Table A.

The solvents in Table A cover a wide variety of organic functional groups which include the following: simple hydrocarbons (hexane), aromatic hydrocarbons (toluene), primary alcohols (methanol, ethanol), polyhydric alcohols (glycerol), carboxylic acids (acetic acid), esters (ethyl acetate), ketones (acetone), carbonates (ethylene carbonate), and finally, water. Another advantage of using the Hansen solubility parameters is that one can compute the solubility parameter for a blend of solvents. The total solubility parameter can be expressed as the square root of the sum of the squares shown in equation 1:

$$\delta_t = \sqrt{(\delta_d^2 + \delta_p^2 + \delta_h^2)} \quad (1)$$

If the solubility of individual solvents in a blend are known, the solubility parameter for the blend can be easily determined,

$$\delta_{\text{blend}} = \sum \Phi_i \delta_i \quad (2)$$

where  $\Phi_i$  is the volume of each solvent in the solvent blend. As an example, if the volume swell results of EPDM in glacial acetic acid and water are known separately, then one can

Chemical	Solubility Parameters		
	d	p	h
Hexane	15	0	0
Acetic Acid	14.5	8	13.5
Acetone	15.5	10.4	7
Ethanol	15.8	8.8	19.4
Ethylene Carbonate	19.4	21.7	5.1
Toluene	18	1	2
Glycerol	17.4	12.1	29.3
WFI (Water)	16.5	23.5	14.8
Benzyl Alcohol	18.4	6.3	13.7
Ethyl Acetate	15.8	5.3	7.2
Methanol	15.1	12.3	23.3

Table A. Solvent list for absorption tests.

estimate the volume swell of a 50/50 volume blend of acetic acid and water. In practice, common sense tells us that if an elastomer is compatible in two given solvents, then they should be compatible in blends of the two solvents, but, it's important to know there is a mathematical relationship to back it up.<sup>8</sup>

## Extraction Methods

The identification and the quantification of the extractables that are obtained from a plastic or elastomer is not as simple as the absorption study. In the absorption study, results were based upon the knowledge of what was being absorbed. In the case of extraction, the solvent is known, but what is actually extracted is unknown. As stated earlier, absorption (volume swell) tests also can determine if there is a bulk weight loss. But, it does not identify what was lost. Identification is hindered by the amount of extract, which can sometimes be as low as a few parts per million. Even if the amount extracted is large, several analytical techniques may be required to determine identity and quantity. Thus, it is necessary to create a more detailed methodology in order to characterize the potential and possible in-service extractables.

## Potential Extractables

In order to understand what organic and/or inorganic materials could be extracted, a study of the elemental composition of a given elastomer is needed. This can be further segregated into two tests: one to identify the atomic elements present in an elastomer, the other to quantify the percentage of organic and inorganic materials. Of course, if the elastomer supplier is willing to divulge the ingredients of its formulation, this step is unnecessary. However, most elastomer manufacturers and compounders consider their formulations to be proprietary and therefore are very secretive about their formulations. In this case, one may have to employ other methods to partially determine the formulation of the elastomer. Two methods that are useful are x-ray fluorescence and thermal gravimetric analysis (TGA).

X-ray fluorescence is a spectroscopic method commonly used to determine the elemental composition of a compound. It can produce a semi-quantitative analysis of the elements present within an elastomer. The method involves reducing the sample to a powder form, pressing it into a wafer or fusing into a borate glass. The results are listed as a weight percent of the total sample.



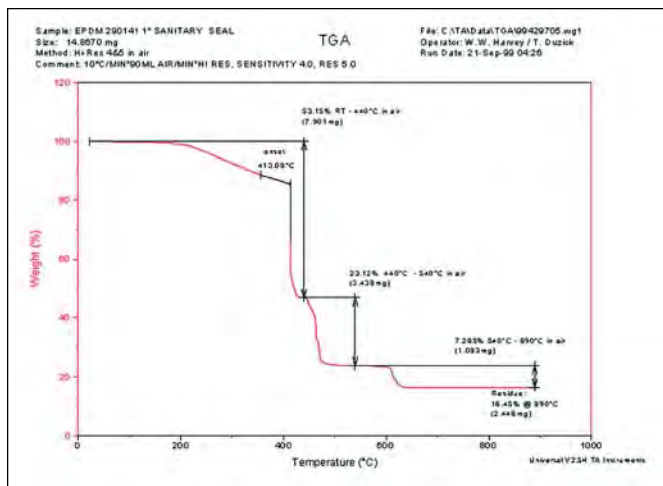

Figure 3. TGA scan of EPDM (data provided by DuPont's Corporate Center for Analytical Sciences).

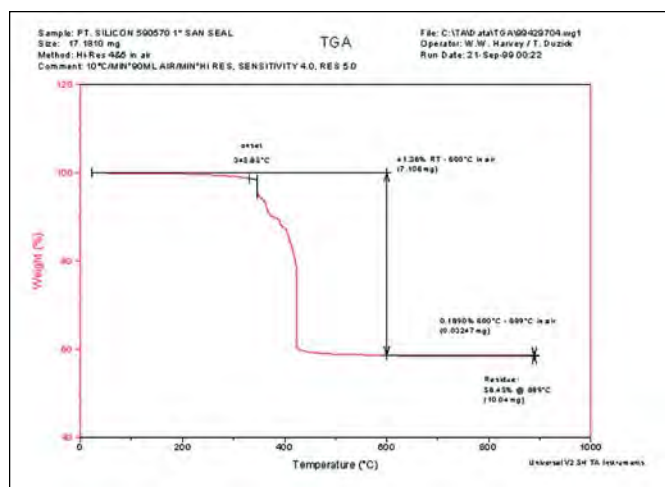

Figure 4. TGA scan of pt-Silicon (data provided by DuPont's Corporate Center for Analytical Sciences).

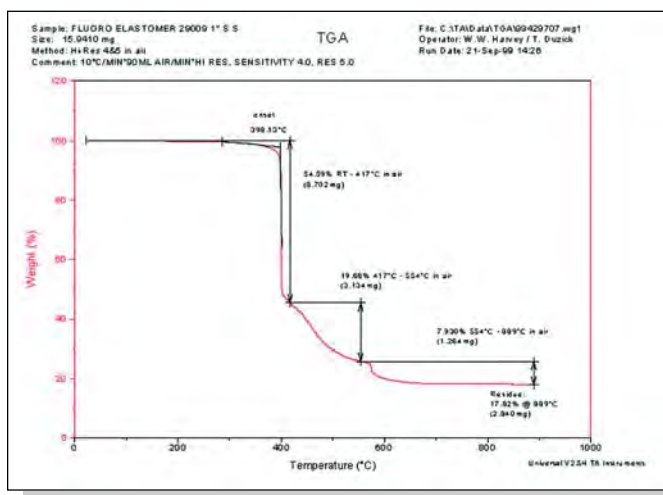

Figure 5. TGA scan of FKM (data provided by DuPont's Corporate Center for Analytical Sciences).

Thermal analytical methods monitor the differences in some sample properties as the temperature increases. Thermal gravimetric analysis (TGA) is the measurement of the weight of a sample as the temperature increases, and can accurately measure the organic, carbon and ash content of an elastomer. A TGA curve of the EPDM elastomer used in this study is shown in Figure 3.

A possible interpretation of the scan is as follows: following the TGA scan from left to right (increase in temperature), the first downward sloping line segment starting around 200°C and ending at 413°C represents the decomposition of plasticizers and other low-molecular weight oligomers. The two vertical lines starting at 413°C and ending at 440°C indicate the bulk decomposition of the elastomer backbone. The dip around 600°C represents the oxidation of the carbon-black filler. The final plateau is the ash content or residue. Everything to the left of 440°C represents organic materials; the rest is inorganic material. The percentage breakdown is 76% and 24%, respectively.

In summary, the use of x-ray fluorescence, coupled with a TGA analysis, provides a reasonable picture of an elastomer's overall composition. Although the two tests do not indicate what particular ingredients were used, the results show whether plasticizers are present, what filler level was used, and the total inorganic and organic contents. X-ray analysis can give an indication of what cure-system was used and the type of filler present (excluding carbon black which can be deduced from the TGA scan). Armed with this information, one can get a clear picture of what to expect when actual extraction tests are run.

### Extraction Tests

Extraction testing in general is not a new concept to the pharmaceutical industry. 21CFR Part 177.2600, *Rubber Articles Intended for Repeated Use*, uses extraction testing as an element to determine compliance. For rubber articles in contact with aqueous foods, 177.2600(e) requires an extraction in water-for-injection (WFI) at reflux for seven hours, followed by another extraction for two hours. The samples are brought to dryness and the residue is weighed. The results are then reported as a weight-loss per square inch of extracted sample. If the residue weight during the first extraction period is less than 20mg/in<sup>2</sup> and the residue weight during the second extraction is less than 1mg/in<sup>2</sup> then the sample meets the extraction testing requirements of 177.2600(e). While this is a good test that can be used to eliminate some candidates, it does not determine what compounds were extracted, nor does it take into account extractables by non-aqueous solutions. A more rigorous analysis of the extract is required.

As with the potential extractables analysis, the extraction tests are segregated by the information obtained. The first test method, gas chromatography mass spectrometry (GC-MS), is an analytical method that can identify and quantify the organic compounds extractable after reflux in an organic solvent or water. This analysis is ideal for identifying the type of plasticizer used in an elastomer formulation and determining the relative solubility of the plasticizer in a given solvent. As stated earlier, a process stream will extract a component of an elastomer if it has an affinity with the process stream.

Another method that quantifies the organic extractables is the Total-Organic-Carbon (TOC) test. This test method calls for the extraction of the elastomer sample after immersion in WFI refluxed for 24 hours. The extract is analyzed by convert-

Element	EPDM	Pt-Si	FKM	Kalrez KLR-		
				6221	6230	PTFE
Be...F	0.1100	0.0000	30.0000	50.1000	46.2000	38.9000
Na	0.0490	0.0290	0.0690	0.1200	0.0900	-
Mg	0.0410	0.0110	2.2900	0.0420	0.0180	0.0060
Al	0.0380	-	0.0320	0.2600	0.0110	-
Si	0.1020	11.3000	0.3100	0.5200	0.3700	0.0037
P	0.0060	-	-	-	-	-
S	0.4900	-	0.0350	-	-	-
So	-	-	0.0220	0.0042	-	-
Cl	0.0120	0.0050	0.0170	0.0090	0.0060	-
Ar	-	-	-	-	-	-
K	0.0101	-	0.0034	-	0.0040	-
Ca	2.3200	-	0.0170	0.1900	0.0048	-
Sc	-	-	-	-	-	-
Ti	-	-	-	6.5000	0.0028	-
V	-	-	-	0.0320	-	-
Cr	0.0580	0.0690	0.0340	0.1220	0.0650	0.0680
Mn	0.0047	0.0028	0.0530	-	0.0032	-
Fe	0.0930	0.0880	-	0.1500	0.0860	0.0810
Co	-	-	-	-	-	-
Ni	-	-	-	-	-	-
Cu	-	-	-	0.0032	-	-
Zn	0.6700	-	-	-	-	-
Sr...U	0.0140	-	0.0127	0.0090	0.0490	0.0030
Ba	-	-	0.4600	0.0420	0.0300	-

Table B. X-ray fluorescence analysis of the various FDA compliant elastomers and PTFE (wt%) (data provided by DuPont's Corporate Center for Analytical Sciences).

ing the TOCs to carbon dioxide by acidification and chemical wet oxidation with sodium persulfate. The carbon dioxide liberated is measured using an infrared detector. This is similar to the GC-MS method except that the solvent is strictly WFI, and the identification of the TOCs is not determined. However, it is a very powerful tool in determining the level of organic extractables since the GC-MS method requires compound identification before the concentration can be determined.

The third extraction analysis is an inorganic analysis of the extracts by inductively coupled plasma emission spectroscopy (ICP). This method can detect at ppm levels certain groups of metals and is described in EPA method 6010A. The analysis involves the reflux extraction of an elastomer in WFI, a basic or acidic solution for a period of time. The extract is then brought to certain pH value then injected into the analytical equipment. Because plasma is used to excite the sample, only inorganic aqueous solutions can be used. ICP analysis is an ideal complement to a x-ray fluorescence analysis since both methods detect metallic elements. If an element found in a x-ray analysis does not show up in an ICP analysis, it can be concluded that the metal in question is compatible with the elastomer.

Overall, the combination of ICP, GC-MS and TOC analyses provides a detailed picture of the inorganic and organic extractables that may be removed by a particular process stream. While not comprehensive in scope, the trio of tests should determine whether further work is necessary or if the extractables have been fully characterized.

Element	EPDM	FKM	Pt-Si	Perfluoroelastomers		
				KLR-6221	KLR-6230	PTFE
Silver	ND	ND	ND	ND	ND	ND
Aluminum	ND	ND	ND	ND	ND	ND
Arsenic	ND	ND	ND	ND	ND	ND
Barium	ND	0.653	ND	ND	ND	ND
Beryllium	ND	ND	ND	ND	ND	ND
Calcium	37.4	5.44	3.23	4.92	2.72	5.45
Cadmium	ND	ND	ND	ND	ND	ND
Cobalt	ND	ND	ND	ND	ND	ND
Chromium	ND	ND	ND	ND	ND	ND
Copper	ND	ND	ND	0.05	ND	ND
Iron	ND	ND	ND	0.2	ND	ND
Potassium	ND	ND	ND	ND	ND	ND
Magnesium	0.627	25.3	ND	ND	ND	ND
Manganese	ND	ND	ND	ND	ND	ND
Molybdenum	ND	ND	ND	ND	ND	ND
Sodium	19.9	13.3	22.3	15.4	13.6	14.9
Nickel	ND	ND	ND	ND	ND	ND
Lead	ND	ND	ND	ND	ND	ND
Antimony	ND	ND	ND	ND	ND	ND
Selenium	ND	ND	ND	ND	ND	ND
Thallium	ND	ND	ND	ND	ND	ND
Vanadium	ND	ND	ND	ND	ND	ND
Zinc	5.65	ND	ND	ND	ND	ND
<b>Total</b>	<b>63.6</b>	<b>44.7</b>	<b>25.5</b>	<b>20.6</b>	<b>16.3</b>	<b>20.4</b>

Table C. ICP results after extraction in sterile WFI for 24 h. at 100°C (ppm) (data provided by Toxikon Corp., Bedford, MA).

## Experimental Design

The five major FDA compliant elastomers examined in this study are ethylene-propylene-diene (EPDM), "steam-resistant" fluoroelastomer (FKM), platinum-cured silicon (pt-Si), and the Kalrez KLR-6221 and KLR-6230 perfluoroelastomers. Samples of EPDM, FKM and pt-Si were obtained from a pharmaceutical equipment supplier and are considered to be representative of the elastomer compounds currently available in the market. In order to maximize exposed surface area and sensitivity, all extraction experiments were run on 1" sanitary seals. All absorption data were run on AS568A-214 o-rings and were fabricated from the same compound as the respective sanitary seals.

X-ray fluorescence and TGA analyses were run at DuPont's Corporate Center for Analytical Sciences. Absorption/Volume swell tests were run by DuPont Dow. ASTM D471, *Standard Test Method for Rubber Property – Effect of Liquids* was used as the test procedure to evaluate the comparative ability of rubber and rubber-like compositions to withstand the effects of liquids. Absorption tests were run for 70 hours. Temperatures were mainly dictated by the boiling points of the respective solvents and are listed with the results in Table C.

An outside laboratory, Toxikon Corporation, located in Bedford, MA performed all extraction tests. TOC tests for each elastomer and PTFE were run on two 1" sanitary seals, which were immersed in 50 mL of sterile WFI at 100°C for 24 hours. The solution was then diluted to 100 mL and analyzed. The full procedure is outlined in EPA method 415.1.

ICP analyses were run on two solutions: sterile WFI and 5% nitric acid. For the sterile WFI test, four 1" sanitary seals were

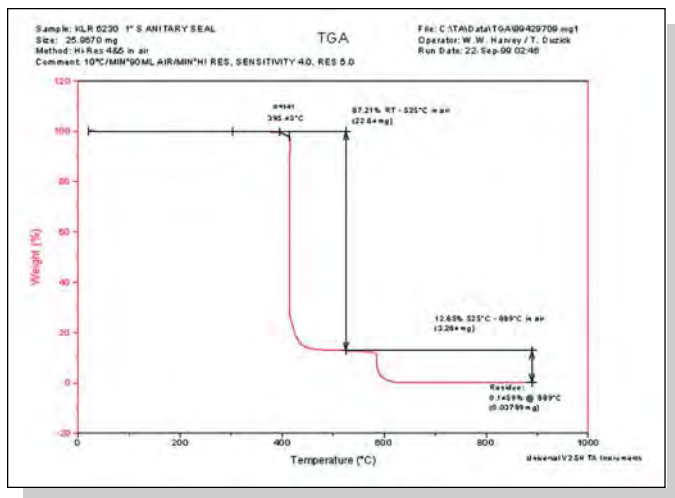

Figure 6. TGA scan of KLR-6230 (data provided by DuPont's Corporate Center for Analytical Sciences).

immersed in 100 mL of WFI at 100°C for 24 hours then analyzed. For the 5% nitric acid test, two grams of each sample were immersed in a 5% nitric acid solution and brought to reflux for 24 hours. The solution was diluted to a final volume of 100 mL and analyzed. The procedure used for both tests is described in EPA method 6010A.

Organic extraction analysis by GC-MS was run on two solvents: methanol and ethyl acetate. Two 1" sanitary seals were immersed in the respective solvents for 24 hours at 60°C. The extract was taken to dryness under nitrogen and brought to volume in 1.0 mL of methylene chloride and analyzed by the EPA Solid Waste (SW) method 8270. Only compounds that could be accurately identified were recorded, even though evidence of other compounds were implied by the GC-MS scan. The analysis was further complicated by the presence of very high molecular weight oils, which are historically difficult to analyze using current GC methods.

### Results and Discussion - Potential Extractables

Before examining the performance of the FDA compliant elastomers in absorption and extraction tests, one should examine the x-ray and TGA data in order to better understand the formulation of these compounds as well as the identification of potential extracts. Table B lists the elements identified by x-ray fluorescence.

The major elements found in EPDM are: sulfur, calcium and zinc with lesser amount of sodium and chromium. X-ray analysis suggests that this particular compound was sulfur cured. TGA analysis, shown in Figure 4, suggests the presence of around 10 -15% plasticizer.

The plateau around 450°C and ending at around 600°C represents the oxidation of carbon black. The ash content (residue) is 16.5% of the weight of the total sample.

The TGA scan of platinum-cured silicon is shown in Figure 4. Considering the absence of sulfur in the x-ray analysis, it is likely that this particular sample was cured with peroxides. Other than silicon, there are no other major elements within the elastomer matrix and only small amounts of iron and chromium. Although the TGA scan suggests there is plasticizer present, it is difficult to determine the quantity. The large residue (58%) is indicative of a silicon rubber filled with fumed silica.

The major elements present in the FKM are magnesium, barium with minor elements silicon, sodium and sulfur. Since elemental barium is found in the filler Blanc Fixe - commonly known as barium sulfate - and there are also small amounts of sulfur, it can be concluded that part of the filler system contains barium sulfate. The absence of large amounts of calcium suggests the compound was diamine cured. The TGA scan (Figure 4) shows very little low molecular weight oligomers. The dip at 554°C represents carbon black. The residue is approximately 18%. The perfluoroelastomers KLR-6230 and KLR-6221, along with PTFE, are shown in Figures 6, 7 and 8 respectively.

Examining figures 6, 7 and 8, it is evident that the TGA scans are similar for all three materials. There is no evidence of low molecular weight oligomers in any of the three samples. The 6.6% residue in KLR-6221 represents the filler titanium dioxide which is identified in the x-ray analysis. Minor elements found in KLR-6221 include silicon, aluminum, chromium and iron. Since the filler in KLR-6230 is carbon black, there are no major elements in the elastomer matrix except for fluorine and carbon. This is supported by the low ash content (0.15%). Minor compounds are limited to silicon, chromium and iron. The TGA of PTFE shows there is no residue. X-ray fluorescence reveals minor amounts of chromium and iron. After examination of the TGA and x-ray fluorescence data, a ranking of the potential organic and inorganic extractables can be created - which are as follows:

Potential Inorganic -  
(PTFE, 6230, pt-SI)< 6221<FKM<EPDM

Potential Organic -  
(PTFE, 6230, 6221, FKM)<pt-Si<EPDM

### Results and Discussion - Extraction Tests

Armed with the potential extractables rating, one can now determine whether the potential extractables analysis does in fact give an indication as to the results of the actual extraction tests. The results of the extraction tests in sterile WFI are shown in Table C.

The elements extracted during the immersion period agree reasonably well with the x-ray fluorescence analysis.

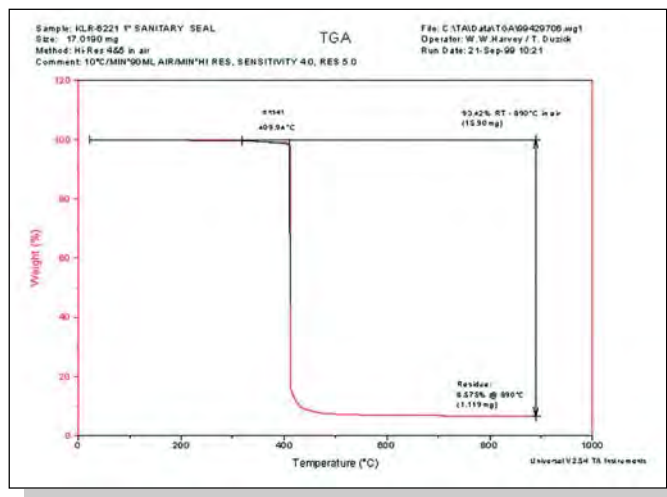

Figure 7. TGA scan of KLR-6221 (data provided by DuPont's Corporate Center for Analytical Sciences).

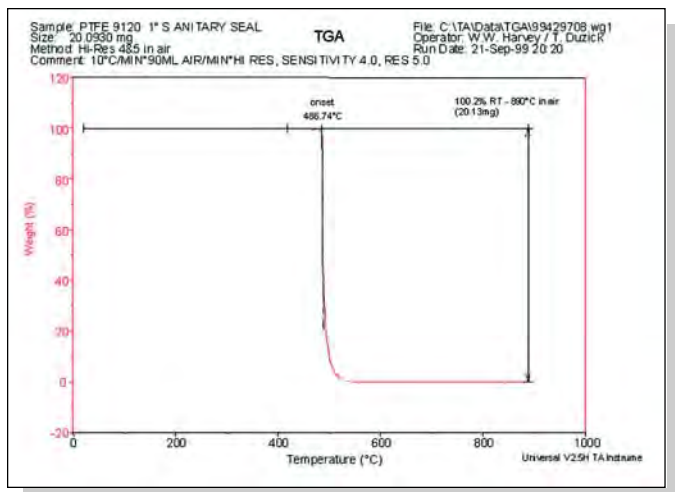

Figure 8. TGA scan of PTFE (data provided by DuPont's Corporate Center for Analytical Sciences).

For example, the presence of zinc and calcium in EPDM is consistent with the major elements found in the x-ray study. This is also true for the FKM. ICP analysis identified barium and magnesium in the extract which also can be found in the x-ray study. What is questionable is the consistent levels of sodium found in all elastomers and PTFE, along with smaller levels of calcium found in all materials except EPDM, which does contain calcium. Ignoring the calcium and sodium levels, the level of inorganic extractables in sterile WFI are highest in EPDM, then FKM. All other elastomers plus PTFE have either very little or no inorganic extractables. In order to increase the sensitivity of the ICP test, 5% nitric acid was used as the test solution. The results are listed in Table D.

The results essentially mirror the sterile WFI results except that the amounts extracted are significantly greater for EPDM and FKM - which was expected. This suggests that the nitric acid test is in fact a more stringent test than the sterile WFI test and produces results with greater sensitivity. There is an exception: nitric acid immersion did not extract any barium from the FKM. In summary, the two ICP analyses suggest the following ranking:

Measured Inorganic -  
(PTFE, pt-SI, 6230, 6221) < FKM < EPDM

The identifiable organic extractables after immersion in methanol are listed in Table E. There were no identifiable compounds extracted after immersion in ethyl acetate.

These results are consistent with the TGA scans that show that EPDM and pt-Si contain some sort of plasticizer while KLR-6230 and PTFE either do not or the concentration of the plasticizer is below the detection limit. Finally, the TOC results after immersion in sterile WFI after 24 h at 100°C are shown - Figure 9.

The TOC results correlate well with methanol extraction results. As with the methanol extraction test, the results show that EPDM and pt-Si contain a moderate amount of plasticizer or other organic compound, while the other elastomers and PTFE either have very little or no plasticizer. Considering both test results, the ranking of organic extractables for all materials is as follows:

Measured Organic -  
(PTFE,6230)<(6221,FKM)<pt-Si<EPDM

As stated earlier, a ranking based upon the potential extractables identified by x-ray fluorescence and quantified by TGA tests showed the following:

Potential Inorganic -  
(PTFE, 6230, pt-SI)< 6221<FKM<EPDM

Potential Organic -  
(PTFE, 6230, 6221, FKM)<pt-Si<EPDM

Measured Inorganic -  
(PTFE, pt-SI, 6230, 6221) < FKM < EPDM

Measured Organic -  
(PTFE,6230)<(6221,FKM)<pt-Si<EPDM

Given the successful match of the ranking of potential extractables versus measured extractables, a conclusion can be drawn that the testing protocol outlined in Figure 4 provides a consistent experimental path for determining extractables from a particular sealing material.

## Results and Discussion - Absorption

The results of the ASTM D471 volume swell tests are listed in Table F.

The results are not unexpected. Since EPDM is essentially a non-polar polymer, one expects significant volume swell in non-polar solvents such as hexane and toluene while performing better in polar solvents such as acetone, methanol and water - to name a few. The negative numbers indicate that the

Element	Perfluoroelastomers					
	EPDM	FKM	Pt-Si	KLR-6221	KLR-6230	PTFE
Silver	ND	ND	ND	ND	ND	ND
Aluminum	14	12.2	ND	ND	ND	ND
Arsenic	ND	ND	ND	ND	ND	ND
Barium	0.771	ND	ND	ND	ND	ND
Beryllium	ND	ND	ND	ND	ND	ND
Calcium	7003	ND	ND	6.98	ND	ND
Cadmium	ND	ND	ND	ND	ND	ND
Cobalt	ND	ND	ND	ND	ND	ND
Chromium	ND	ND	ND	ND	0.95	ND
Copper	ND	ND	ND	ND	ND	ND
Iron	34.3	6.65	2.27	1.81	5.15	1.05
Potassium	ND	ND	ND	ND	ND	ND
Magnesium	59.6	2750	ND	ND	ND	ND
Manganese	8	ND	ND	ND	ND	ND
Molybdenum	ND	ND	ND	ND	ND	ND
Sodium	89.9	ND	ND	ND	ND	ND
Nickel	ND	ND	ND	ND	ND	ND
Lead	ND	ND	ND	ND	ND	ND
Antimony	ND	ND	ND	ND	ND	ND
Selenium	ND	ND	ND	ND	ND	ND
Thallium	ND	ND	ND	ND	ND	ND
Vanadium	ND	ND	ND	ND	ND	ND
Zinc	996	4.7	1.64	ND	ND	ND
<b>Total</b>	<b>8205.6</b>	<b>2773.6</b>	<b>3.9</b>	<b>8.8</b>	<b>6.1</b>	<b>1.1</b>

Table D. ICP results after extraction in 5% nitric acid at reflux for 24 h. (ppm) (data provided by Toxikon Corp., Bedford, MA).

Material	Compound Extracted	Conc. (ppb)
EPDM	Diethylphthalate	3.39
	n-Nitrosodiphenylamine	51.71
	Di-n-butylphthalate	9.66
	bis(2ethylhexyl)phthalate	9.57
	Di-n-octylphthalate	1.43
pt-Si	Benzyl Alcohol	1.90
	2-Methylphenol	1.34
	Diethylphthalate	8.79
	Di-n-butylphthalate	4.35
	Butylbenzylphthalate	1.60
	bis(2-ethylhexyl)phthalate	4.93
FKM	bis(2-ethylhexyl)phthalate	1.54
KLR-6221	bis(2-ethylhexyl)phthalate	1.39
KLR-6230	ND	-
PTFE	ND	-

Table E. Identified organic extractables from the various FDA compliant elastomers and PTFE after immersion in methanol (ppb) (data provided by Toxikon Corp., Bedford, MA).

plasticizer used in EPDM is susceptible to leach out in those particular solvents. Platinum-cured silicon (pt-Si) is also a non-polar polymer, but the test results suggest that the chemical resistance of pt-Si is much greater than EPDM, and that the plasticizer used is less likely to be extracted—or if it is, at lower levels—when exposed to similar solvents. The volume swell results for the FKM are consistent with a diamine cured FKM. Since FKM contain VF<sub>2</sub>, a polar-like monomer, it is expected that this FKM would be susceptible to swelling by polar solvents and organic acids. Also, diamine cures do not provide the chemical resistance provided by bisphenol or peroxide cures. The perfluoroelastomers KLR-6221 and KLR-

	Temp				Kalrez	Kalrez
Chemical	(C°)	EPDM	pt-Si	FKM	6230	6221
Hexane	60	41	4	6	7	7
Acetic Acid	100	135	1	199	3	19
Acetone	50	-6	2	65	4	3
Ethanol	60	-9	10	18	1	1
Ethylene Carbonate	100	-3	0*	64	0	0
Toluene	100	155	50	86	6	6
Glycerol	100	0	1	0	0	0
WFI (Water)	100	24	-	20	2	7
Benzyl Alcohol	100	-7	2	10	1	1
Ethyl Acetate	60	3	11	118	5	5
Methanol	60	-5	-2	67	1	1
<b>Additional</b>						
20% Nitric	100	139	-2	309	1	10
15% NaOH	100	0	0*	10	1	1

Table F. Volume swell results for the various FDA compliant elastomers after an immersion time of 70 h. (%) (data provided by DuPont Dow Elastomer Fluoroelastomer Development Facility).

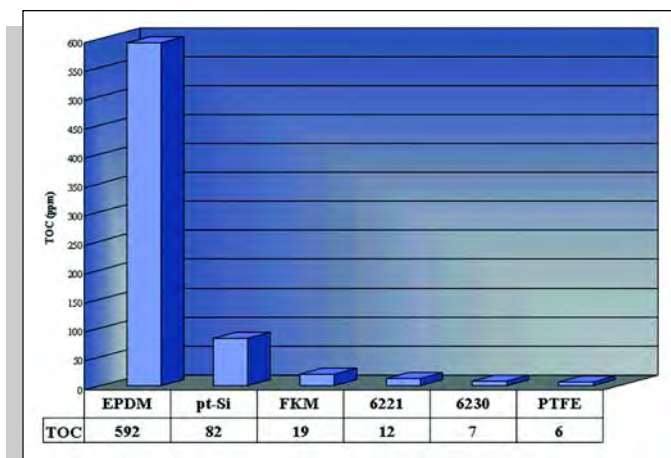

Figure 9. TOC results (data provided by Toxikon Corp., Bedford, MA).

6230 are non-polar polymers with complete fluorine substitution. This substitution affords excellent volume swell resistance in a variety of solvents - both polar and non-polar.

## Conclusions

Based upon the extraction data presented in this study, it can be concluded that 6230 is as “clean” as PTFE. For example, the measured TOCs for 6230 and PTFE are seven ppm and six ppm respectively. These levels are essentially equivalent given that the concentration difference is only 1 mg/g. The same comparison can be made when one examines at the inorganic extraction data. The perfluoroelastomers 6230 and 6221, along with pt-Si and PTFE, have less than 10 ppm of metals extractables, compared to 2800 ppm and 8200 ppm for FKM and EPDM respectively when extracted in 5% nitric acid.

Absorption data shows that both KLR-6230 and KLR-6221 greatly outperform the other elastomers tested, especially in polar solvents such as: methanol, ethanol and water. The results also show that both perfluoroelastomers are resistant to 20% nitric acid—the solution commonly used to passivate stainless steel, and 15% sodium hydroxide, a clean-in-place solution.

Thus, the perfluoroelastomers KLR-6221 and KLR-6230 are suitable for a vast majority of pharmaceutical applications, especially in applications where PTFE is currently used.

## Comments

This work is by no means exhaustive. There are many areas of further study that can complement the data listed in this report. For example, the solvents chosen did not include nitrogen or amine containing solvents such as acetonitrile or isopropylamine. Including these solvents, plus triethanolamine - an alcoholic amine would provide a more complete absorption analysis. Another group of solvents that could be added would be the halogenated solvents. Also, another area of refinement is in the potential extractables analysis. By further calibrating the x-ray fluorescence instrument before an analysis, the mass amounts detected by x-ray fluorescence can be compared to the TGA residue. If the form of the elements identified by x-ray analysis is known (i.e., oxide, chloride, or sulfate), then a full mass balance can be calculated.

Finally, the absorption results can be coupled with retained tensile properties and compression set results in order to determine the total retained mechanical properties of the various elastomers after exposure to a process stream.

The author would like to thank Kevin Klausner of Toxikon, Mimi Keating and Mike Martin of DuPont's Corporate Center for Analytical Sciences, and Mike Coughlin, James Alexander, and Deb Wellman of DuPont Dow Elastomers for their help.

### References

1. American Society of Mechanical Engineers, Bioprocessing Equipment-1997, ASME, New York, 1997, p iii.
2. Lawrence H. Van Vlack, Elements of Material Science and Engineering, 6<sup>th</sup> Ed., Addison-Wesley Publishing Company, New York, 1990, pp 535-536.
3. Richard J, Lewis, Sr., Hawley's Condensed Chemical Dictionary, 12<sup>th</sup> Ed., Van Nostrand Reinhold Company, New York, 1993, p 942.
4. M. Brown, Seals and Sealing Handbook, Elsevier Science Publishers, LTD., Oxford, UK, 1995, p 93.
5. Robert F. Ohm, Ed., The Vanderbilt Rubber Handbook, R.T. Vanderbilt Company, Inc., Norwalk, CT, 1990, pp 135-136.
6. Alan N. Gent, Ed., Engineering with Rubber, Hanser Publishers, Oxford Press, New York, 1992, p 28.
7. Carl J. Weitzmann, *The Use of Model Solvents for Evaluating the Extractables from Filters Used to Process Pharmaceutical Products, Part 1.*, BioPharm, Volume 10(4), 1997.

8. Wesley L. Archer, Industrial Solvents Handbook, Marcel Dekker, Inc., New York, 1996, pp. 57-68.

9. ©Kalrez is a registered trademark of DuPont Dow Elastomers, L. L. C.

### About the Author

**Timothy C. Duzick** is an Applications and Development Engineer for DuPont Dow Elastomers. He has worked in many areas of fluorine chemistry for the last 12 years including fluoropolymer coatings development, and fluoromonomer and fluorochemical process development. He has co-authored a paper on the techniques of measuring holographic optical elements made from fluoropolymer films as well as the techniques of measuring fluorination rates of substituted ethanes. He is currently involved in applications and design issues associated with Kalrez in pharmaceutical, cosmetic and food handling applications. Duzick received a Master of Engineering degree at Widener University, and is a member of ISPE.

DuPont Dow Elastomers L.L.C., 1 Innovation Way, Suite 400, Newark, DE 19711. 

This article outlines the need to establish positive safeguards between process equipment and related dust collection systems.

Reprinted from  
**PHARMACEUTICAL ENGINEERING®**

The Official Journal of ISPE  
March/April 2000, Vol. 20 No. 2

# Dust Explosion Protection in Pharmaceutical Processing

by Michael P. DeBellis

## Is Your Pharmaceutical Process Equipment Properly Protected From Your Dust Collector?

**W**ith the continuous development of new products, the variety and quantity of materials used in powder form has increased. A potential dust explosion can occur wherever combustible or explosible dust exists, regardless of whether it is being processed, handled, accumulated or stored. Dust explosions have caused many industrial accidents - approximately 10 per year (excluding the mining industry) - with fatalities and property damages tallying in the millions of dollars.

The circumstances surrounding dust explosions are diverse. Explosions have involved a variety of materials such as: wood, resins, starches, sugars and aluminum; and have occurred during crushing, pulverizing, grinding, blending, drying, conveying and in dust collectors during collection. Typically, pharmaceutical solid dosage facilities use dust collectors throughout the manufacturing process. They can be found in weighing, dispensing, conveying, tableting and tablet coating operations.

This article will outline the need to establish positive safeguards between process equipment and related dust collection systems. It will review (1) just how explosive some commonly

used pharmaceutical materials can be, (2) the potential for secondary explosions to occur, and (3) the need to protect downstream equipment from the potential of blowback from an explosion in a dust collector. The article focuses primarily on the author's experience with a tablet coating system that uses solvent-based coating solutions, outlining the author's recommended practices for: (a) isolating the dust collector from downstream equipment, and (b) providing proper explosion and fire protection to personnel, process equipment and the manufacturing facility.

### What is a Dust?

According to the NFPA 68, Guide for Venting of Deflagrations (1998 Edition), a dust is any finely divided solid, 420 micrometers or 0.017 inches or less in diameter. In other words, any material capable of passing through an US No. 40 standard sieve is classified as a dust. The fineness of a particular dust is characterized by its particle size distribution.

Dust particle size can be reduced as a result of attrition or size segregation during material handling and processing. Such handling and processing can lead to the gradual reduction of the average particle size of the material being handled and can increase the deflagration hazard of the dust. A deflagration is defined as the propagation of a combustion zone at a velocity that is greater than the speed of sound in the unreacted medium. An explosion is the bursting or rupturing of an enclosure or container due to the development of internal pressure from a deflagration.

### Deflagration

A deflagration can occur when the following conditions exist:

- fuel concentration is within flammable limits

Dust collector with an explosion suppression system.



Examples of Explosive Powders	
Dust	K <sub>st</sub> (bar-m / sec)
PVC	50
Sugar	80
Coal	85
Polythene (Coarse)	115
Polythene (Fine)	150
Starch	150
Cellulose	160
Maize	195
Dextrin	200
Organic Pigment	286
Aluminum	555

Examples of Explosive Gases	
Gases	K <sub>g</sub> (bar-m/sec)
Methane	55
Propane	75
Toluene	56
Methanol	66
Hydrogen	550

Table A. Examples of explosive dusts and gases.

- oxidant concentration is sufficient to support combustion
- an ignition source is present

The deflagration pressure, P, in a closed volume, V, is related to the temperature, T, and molar quantity, n, by the following ideal gas law relationship:

$$P = nRT/V \text{ where } R \text{ is the universal gas constant}$$

The maximum deflagration pressure - P<sub>max</sub>, and rate of pressure rise - dP/dt, are determined by testing over a range of fuel concentrations. These are key factors in the design of deflagration protection systems. The deflagration index, K, is calculated from the maximum rate of pressure rise attained by combustion in a closed vessel with a volume, V, as follows:

$$K = (dP/dt)_{\max} V^{1/2}$$

The value of (dP/dt)<sub>max</sub> is the maximum for a particular fuel concentration, referred to as the optimum concentration. The K<sub>St</sub> factor is the deflagration index for a dust material and the K<sub>G</sub> factor is the deflagration index for a gas. The maximum pressure and K<sub>St</sub> increase with a decrease in dust particle size. Some examples of explosive dusts and gases are listed in Table A. Table B indicates hazardous explosion classifications.

Deflagrations, which occur in enclosures that are not strong enough to withstand the pressure, will result in explosions,

Explosion Group	K Value (bar-m/sec)	P <sub>max</sub> (bar)	Explosion Characteristics
St 0	0	0	No Explosion
St 1	0-200	0-10	Weak to Moderate
St 2	201-300	0-10	Strong
St 3	00-800	12	Very Strong

Table B. Hazardous explosion classifications.

causing damage to systems and possible injury to nearby personnel.

Explosive conditions will exist if the dust is:

- flammable
- airborne
- the right particle size to allow combustion
- has a concentration within its flammable range
- in the presence of an ignition source with sufficient energy
- in an atmosphere that supports combustion
- P<sub>max</sub> exceeds equipment design pressure rating

Approximately 70% of all dusts are flammable. A flammable dust is a dust that will propagate a flame in a homogenous mixture with a gaseous oxidizer. What is the difference between a flammable dust and an explosive dust? When a flammable dust meets the above criteria it has become an explosive dust.

## Explosions

A flammable dust will not ignite unless an ignition source of sufficient energy is present. Ignition sources are friction, overheating or spontaneous heating, flames, tramp metals, welding and cutting, static electricity and electricity. Flame propagation occurs in clouds of combustible dust due to the combustion of flammable gases emitted by particles heated to the point of vaporization or pyrolysis. Some dusts can propagate a flame through direct oxidation at the particle surface. As a result, the chemical and physical makeup of a dust has a direct bearing on its means of propagating a flame when dispensed in air.

See Figure 1, the Fire/Explosion Triangle. The risk of a fire or explosion is removed when any one side of the triangle is removed from the other. One must either eliminate potential dust concentrations or dust clouds from forming (fuel), or remove potential ignition sources, or remove oxygen from the atmosphere, such that the atmosphere will not support combustion. When this cannot be accomplished, then measures should be taken to protect personnel and minimize potential damage to the facility.

## Is Your Dust Explosive?

Your facility may be processing materials regularly and has never experienced any explosion. However, it should **not** be automatically assumed that your material is safe or non-explosive. Operations and Maintenance personnel rely upon information provided on the Material Safety Data Sheet (MSDS) for a specific material. The MSDS provides information on the material only as used in its standard concentrations and/or particle size, not in dust form. A material can be classified as non-explosive, but contain dusts (reduced particle size) which will behave as an explosive material.

Check that your material particle size matches the particle size classified in the material literature. If you have no available data on your material, or the data is somewhat ambiguous, then the material should be submitted for complete and thorough explosivity testing by a certified testing laboratory or



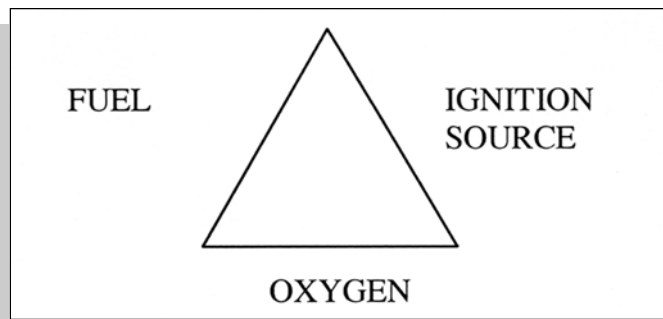

Figure 1. The "Fire/Explosion Triangle."

an explosion protection equipment manufacturer. The material will be classified by exposing it to various ignition sources to determine its explosivity. Ignition sources will range from chemical igniters to a welding torch flame. If these ignition sources do not yield an explosion, it is generally considered non-explosive during normal handling.

However, consider your entire process before deciding that the dusts are not explosive. Think about your weighing, dispensing, milling, tableting, tablet coating and bin charging areas, etc. Are you aware of or have you tested all your materials as a dust? Combustible dusts that accumulate on surfaces in process areas can become airborne by sudden air movement or mechanical disturbances. Dusts can pass through ruptured filter elements, becoming a combustible concentration of dispersed dust where it normally would not be present. Does your process include both a solvent and a non-explosive dust? You will need to determine whether the solvent's interaction with the dust material can be cause for an explosion. An example of where such a condition could exist is in a solvent-based tablet coater. See Tablet Coaters.

### Explosivity

If the literature or explosivity test indicates that you have an explosive material, you need to determine the dust's explosion parameters. There are five standard tests used to determine a dust's explosion parameters. These parameters are as follows:

#### 1. Pressure and rate of pressure rise for combustible dusts -

Min. Ignition Energy (millijoules)	
500	Low sensitivity to ignition. Grounding of all equipment in contact with a powdered material that has an ignition energy at or below this level.
100	Consider grounding personnel when in contact with a powdered material that has an ignition energy at or below this level.
25	The majority of ignition incidents occur when ignition energy is at or below this level. The hazard from electrostatic discharges from dust clouds should be considered.
10	High sensitivity to ignition. Take the above precautions and consider restrictions on the use of high resistivity materials (plastics). Electrostatic hazard from bulk powders of high resistivity should be considered.
1	Extremely sensitive to ignition. Precautions should be taken for all flammable liquids and gases when ignition energy is at or below this level.

Table C. Guide to electrostatic precautions for powders.

this test is used to quantify the dust explosion pressure created by the different concentrations of your dust.

2. Minimum Explosible Concentration (MEC) for suspended dusts - as the dust concentration in the dust cloud (suspended dust) decreases,  $P_{ex}$  and  $(dp/dt)_{ex}$  also decreases until a certain dust concentration, no explosion can occur.
3. Maximum allowable Oxygen Concentration (MOC) to prevent dust explosions - this test determines the highest percentage of oxygen you can use without causing your dust to explode by increasing the nitrogen level in the surrounding atmosphere, reducing the oxygen content which reduces the  $P_{ex}$  and  $(dp/dt)_{ex}$ , preventing an explosion.
4. Minimum spark ignition energy to create dust explosion - determines the Minimum Ignition Energy (MIE) an electrostatic spark needs to ignite a dust cloud at normal or ambient pressure and temperature.
5. Minimum Auto-Ignition Temperature (MAIT) for dust clouds - determines the minimum temperature at which a dust will auto-ignite when exposed to hot air or hot surfaces. This is especially critical if the material undergoes a drying step in the process.

A minimum ignition energy guide is listed in Table C.

As seen with gases and vapors, dust-air mixtures are only flammable within certain concentrations known as the lower explosive limit and upper explosive limit. The lower explosive limit (LEL) or minimum explosible concentration (MEC), is the smallest dust concentration capable of igniting and sustaining flame propagation. A range of 0.01 - 0.05 kg per cubic meter is typical for most dusts. It is this level that is important in the real world of operating a plant or equipment where dust is either handled or processed. Even if the dust at the initial pick-up point or point of collection is not concentrated enough to ignite, it may become concentrated to within explosible levels within a dust collector.

### Dust Collectors

Dust collectors are widely used in the pharmaceutical industry as well as the chemical and coal mining industries. The basic operations in dust collectors of any type is separation of dust-laden air streams by capturing them on a collecting surface such as a filter, retention of the dust particles and removal of the dust for recovery or disposal. Dust captured in filters will concentrate and the accumulated dust is gravity fed into drums for manual removal via a discharge valve. As the dust accumulates and increases in concentration so does the explosion potential. Within the oxygen-rich environment of a dust collector, many dusts are explosive or even self-igniting, making it extremely difficult to prevent. Dust collectors are usually connected directly to the dust generating source (i.e., spray dryer, tablet press, tablet coater) during filling of the Intermediate Bulk Container (IBC) etc. and require proper isolation in the event of a deflagration or fire in the dust collector.

The potential exists for a flammable dust or flammable vapor present in the dust - air environment to cause flame propagation in a dust cloud and create a secondary concern in dust collection systems and connecting equipment. Hybrid mixtures of gas and dust may demonstrate a reduced apparent lower flammable limit and ignition energy for these types of

“ **The potential exists for a flammable dust or flammable vapor present in the dust - air environment to cause flame propagation in a dust cloud and create a secondary concern in dust collection systems and connecting equipment.** ”

mixtures, even though the dust and gas are individually below their respective lower flammable limits. The heat generated during drying operations or static electricity may serve as ignition sources inside the dust collector.

It also has been shown that the introduction of flammable gases into a cloud of dust that is normally a minimal deflagration hazard, can result in a hybrid mixture with increased maximum pressure and maximum rate of pressure rise. An example of this phenomenon is the combustion of polyvinyl chloride dust in a gas mixture such as methane. Situations where hybrid mixtures can occur in pharmaceutical processes include fluid bed dryers drying solvent wet combustible dusts, and solvent-based tablet coating operations. Careful evaluation of the ignition and deflagration characteristics of the specific mixture is strongly recommended.

If the dust material produces an explosive environment in your dust collector, you can manage the problem using three different methods: explosion venting, total containment or explosion suppression to protect your operators, equipment and your facility.

### Explosion Venting

Explosion venting is the most common method of protecting enclosures from the potential overpressures generated by a

dust or vapor explosion - *Figure 2*. Explosion vents provide a predetermined opening for flame and gases to escape from an enclosure, and limit the pressure generated in an enclosure by a deflagration. Rather than preventing an explosion, the vent relieves the rapidly rising pressure of the expanding gases through an opening engineered for this purpose, and redirects the deflagration to a safe area. The pressure generated is reduced to a pressure that is below a maximum pressure which would cause unacceptable damage to the enclosure.

The explosion vent is less expensive than an explosion suppression system or a containment system. There are four types of vents available: simple cover, blow-off panel, rupture panel and hinged doors each with their own advantages and disadvantages. The NFPA 68 provides guidelines for the design, sizing and application of explosion vents. Factors that influence the size requirements of the vent include the following:

- volume of the enclosure
- maximum pressure allowed during venting
- static bursting pressure of the venting device
- explosion severity of the potential hazard ( $K_{st}$  or  $K_{G}$ )

Consult your dust collector manufacturer or explosion protection equipment manufacturer to assist you in determining the best vent for your application.

Should the vent not rapidly achieve its full open position, the venting of pressure will become restricted. For this reason, it is important to use explosion vents with a low mass per unit area. Conversely, some thin membranes may open randomly leaving the vent opening partially blocked. Select explosion venting devices that are fast opening and provide controlled burst patterns. Be sure to obtain certified burst pressure documentation in accordance with the NFPA 68 guidelines.

### Explosion Suppression

If you have to prevent all damage to your equipment or if the equipment is located in an area where no safe area is available to vent the explosion, it is recommended to use a suppression system. The suppression system senses the deflagration's pressure rise and before it can fully develop, releases a suppression agent such as halogenated hydrocarbon or carbon dioxide. Bicarbonate suppression materials are used predominately in the pharmaceutical industry because they are inert and will not react with the process materials. *Figure 3* shows a typical explosion suppression system installation in a dust collector. *Figure 4* shows an actual installation.

### Explosion Containment

A containment system uses a dust collector designed to absorb the explosive shock. Such a collector would have thicker vessel walls and flanges. Connecting ductwork and isolation valves to complete the containment system also will be required. The



*Figure 2. Typical explosion vents.*

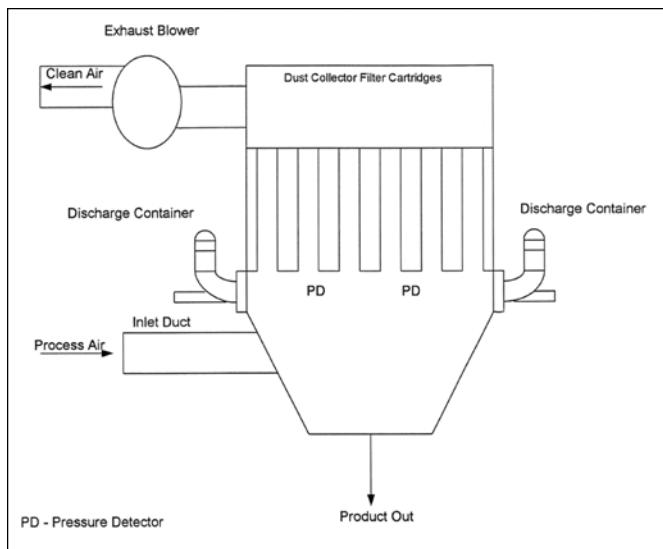

Figure 3. Typical explosion suppression system installation in a dust collector.

NFPA Code 85F provides general guidelines for designing equipment to contain explosions.

### Explosion Isolation

Explosion isolation has been practiced in Europe for many years; however, it is still relatively new in the US. The objective is to prevent the spread of an explosion by blocking the potential flame paths (i.e., process piping or ductwork) that lead to other process equipment or operator occupied areas. Even where the process vessels are protected by venting or other means, the potential for flame and pressure to carry through to other areas can result in additional fire and/or explosion hazards.

The faster the deflagration flame front is detected, the faster the deflagration isolation can be accomplished. Response time and operational reliability of your system components are critical in providing explosion isolation at the earliest possible moment. Figure 5 shows an explosion isolation valve installation.

### Tablet Coaters

In tablet coating operations, compacted dry particulate materials in a pill or tablet form are sprayed with a liquid coating. The coating can be aqueous or solvent based. Solvent based coating operations, where a batch of tablets is loaded into a rotating drum, are sprayed with a liquid solution containing hydrocarbon solvents. During the coating process the solvent is evaporated, and leaves behind a coating on each of the tablets. Air is introduced into the rotating drum, and exits with the solvent vapor and dust particles (fines) generated by broken or chipped tablets (resulting from the tumbling of the tablets in the rotating drum). The presence of a flammable gas in a dust-air mixture reduces the apparent lower flammable limits and ignition energy. The effect can be considerable, and can occur even though the gas is below its lower flammable limit and the dust is below its lower flammable limit.

Typically, the exhaust air in a tablet coater is connected to a dust collector. In the exhaust airstream, the airstream may contain both dust and solvent vapors. In this case, the risk of a deflagration resulting in an explosion increases significantly. Additional explosion protection should be added to

these dust collector systems. In addition to the collector's explosion vent, an explosion suppression system may be required. The addition of explosion isolation valves also may be required upstream of the dust collector and downstream of the tablet coater unit. In the event of a deflagration, flame propagation may occur, and if not properly isolated, could cause a secondary explosion in the coating pan or connecting ductwork.

Solvent detection also should be employed in the tablet coating room and exhaust air duct. Control should be established to increase the exhaust air fan speed to dilute the solvent vapor to air concentrations while simultaneously stopping the solvent solution supply pump. In the event of leakage to the tablet coating room or solution prep areas, solvent detection and alarms should be used to safeguard personnel from these events. The worst case scenario would be a deflagration in the dust collector - setting off a secondary solvent vapor explosion which could propagate back through the tablet coater. Explosion isolation valves will prevent this from occurring. Remember to ensure that the exhaust ductwork is pressure rated for containing such an explosion or your protection system will be inadequate. Typically, tablet spray coating machines are not designed to withstand the pressures generated from explosions occurring either in the pan or connecting ductwork. The perforated pan design does not lend itself to containment designs, since this would inhibit airflow around the tablets. Typically, suppression systems are employed in solvent-based coaters and prevent an explosion from occurring within the pan.

However, when incorporating explosion isolation valves in the exhaust duct to protect the coater from any potential dust collector explosions, the duct must be properly rated to contain the generated explosion pressures or the duct can incorporate an explosion vent. Ten bar (145 psi) is a typical design pressure rating for containment. A recommended explosion protection system, as depicted in Figure 5, should be used in a solvent based coating operation where an explosive powdered material is used in the formation of the tablets to be coated. This system incorporates explosion suppression, venting and explosion isolation protection method. Figure 6 illustrates suggested locations for establishing explosion protection in a solvent based tablet coating system and does not depict all the necessary sensors and related devices to fully describe an actual system.



Figure 4. Explosion suppression system installed in a dust collector.



**If the dust material produces an explosive environment in your dust collector, you can manage the problem using three different methods: explosion venting, total containment or explosion suppression to protect your operators, equipment and your facility.**



In order to evaluate whether your process has the potential to become explosive, the following parameters should be determined:

- possible fuel sources
- possible ignition sources
- potential hazard volume
- potential hazard geometry (length/diameter or aspect ratio)
- operating pressures and temperatures
- internal obstructions or moving components
- operating cycles
- all names of fuel components

- $P_{max}$  and  $K_{max}$  values
- Minimum Ignition Energy (MIE) value for each fuel identified

This information defines and helps visualize potential explosion incidents. It is particularly helpful in identifying where an explosion could originate and how it may propagate within the process equipment or system.

After defining the explosion hazard, the protection method has to be determined. There are generally two categories that describe current protection methods:

1. Venting - reducing the pressure generated during a deflagration to below the ultimate design strength of the process equipment. Included with this method is explosion suppression as it also achieves an explosion pressure reduction to a safe level.
2. Isolation - preventing the deflagration from propagating to other locations in the process.

The last and final step in determining the proper protection for your dust collector and process is to determine what type of hardware will be used and where it will be located. Choosing the proper hardware devices involves identifying activation points of these devices (the point at which the explosion pressure can be detected or responded to). Each explosion vent has a burst pressure at which it starts to open. The static burst pressure is a critical design parameter for the proper operation of the vent. Vent area is also important and must be determined by calculation in accordance with the NFPA guidelines. The discharge of the vents must be considered when locating the dust collector explosion vents. Venting must be located in a safe area and allow full unobstructed venting when activated.

Isolation valves and suppression systems use pressure detectors to activate them. Each pressure detector has a static activation point at which it begins sensing the increase in pressure inside the equipment being protected. The static burst pressure of a vent and the detector set point is chosen with respect to the operating pressure of the equipment. Typically 0.5 psig above the maximum operating pressure of the equipment is recommended.

With isolation valves, the diameter is obviously important; however, the location of the valve with respect to the detector is crucial to allow for the proper response time of the valve after receiving the activation signal from the detector. Both the maximum and minimum placements of the valve and detector must be determined in order to assure proper explosion isolation.

### Summary

There is no one protection method which can provide protection to all types of process equipment. Each type of protection



Figure 5. An explosion isolation valve.

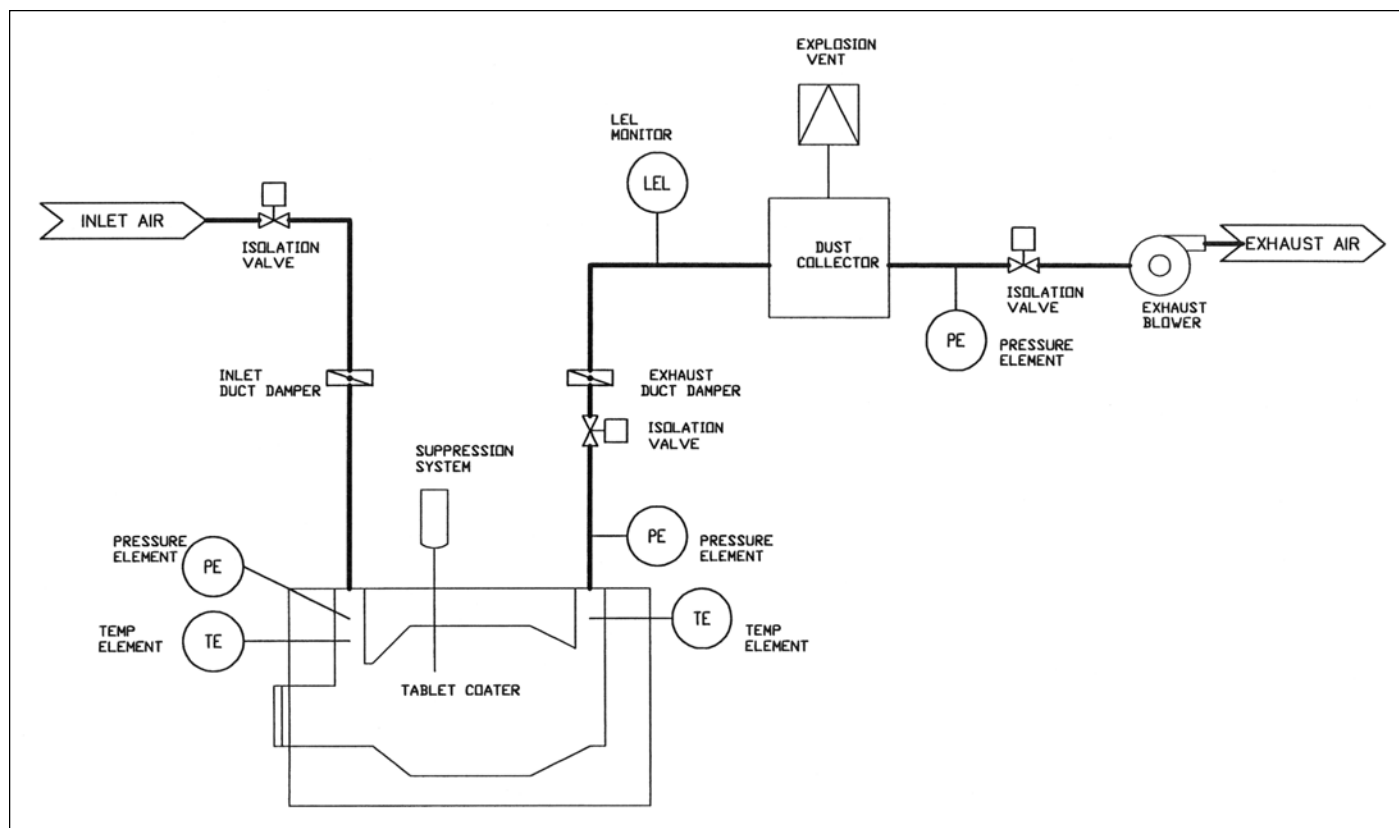

Figure 6. Suggested locations for establishing explosion protection in a solvent based tablet coating system.

method has various applications, and at times, may be combined to provide optimum protection for your equipment, personnel and facility.

As a general rule, if a material can burn under the right conditions, it can and will explode. Seek the recommended designs and advice of experts in explosion technology and submit all powdered materials used in a facility for thorough explosivity testing. Have your materials tested for the LEL as a dust and do not rely on the MSDS information. Eliminate potential ignition sources, and provide dust containment wherever possible. Most dust collector manufacturers do not supply explosion suppression systems or explosion isolation valves. Both require detailed engineering. Drawings should be provided showing exact locations of each component on the process equipment, mounting details and electrical wiring.

It only takes one incident to injure or kill personnel, severely damage your equipment or shut down the facility.

### References

1. NFPA Code 68, Guide for Venting of Deflagrations, National Fire Protection Association, 1998 Edition.
2. NFPA Code 69, Standard on Explosion Prevention Systems, National Fire Protection Association, 1997 Edition.
3. Center for Professional Advancement Course on "Preventing Dust Explosions," presented by Chilworth Technology, Sept. 1995.

*Note: Special thanks to Fike Corporation for providing photos.*

### About the Author

**Michael P. DeBellis** is a Principal Engineer for Sharp Design's BioPharm Division in Robbinsville, NJ. His responsibilities include marketing, sales, business development and execution of all pharmaceutical related projects. Currently focusing upon pharmaceutical solid and liquid dosage fill finish and packaging facilities, DeBellis has more than 13 years of experience in the biotech and pharmaceutical industries. During this period he has been involved in all aspects of engineering and design for process related systems and equipment for biotech/pharmaceutical type facilities. DeBellis is a graduate of New Jersey Institute of Technology and has earned a BS in mechanical engineering. He is also an active member of the ISPE Delaware Valley Chapter's Program Committee and Board of Directors.

Sharp Design, Inc., 1 AAA Drive, Suite 202, Robbinsville, NJ 08691. 